



2022

NEW PRODUCT PREVIEW

THE WORLD'S **BEST** CYCLING ACCESSORIES



 **TOPEAK**[®]
PREPARE TO RIDE

For more information about Topeak, please contact your nearest Topeak authorized bicycle distributor or visit our Website: www.topeak.com

Product specifications subject to change without prior notification. All content © Topeak, Inc. 2022 03/2022









As one of the great spirits in this sport, exploring unknown paths and the landscape ahead is integrated in our product DNA. We explore the possibilities with engineering and design from every great epic bike journey to your petit adventure of local rides. The solutions we provide, are the innovations we've discovered from those insights.

For the 2022 season Topeak introduces over fifty new and updated products you're sure to covet. We've added two new Transformer Series bike stand / floor pumps, CO₂ inflators and tools specifically designed for tubeless tire repair, new Torq Stick wrenches and shop tools for novice mechanics and pros alike, DF series accessories for multi-use, Apple™ AirTag mounts, ultralight Fezā carbon water bottle cages for optimized weight and function, new bags, essential bike fenders, motorcycle RideCase mounts, and a host of other products for every cyclist. With over 30 years of creating the finest accessories, Topeak continues to lead the way.





PREPARE TO RIDE







PUMP SERIES

PUMP+STAND		2 STAGE			CO ₂ INFLATOR + PUMP
2 STAGE		DIGITAL			
					
Transformer [®] eUP 2Stage Page 07	Transformer [®] eUP Page 09	Mountain 2Stage Digital Page 11	Gravel 2Stage Page 13	Roadie 2Stage Page 15	HybridRocket HP Mini Page 17

TOOL SERIES

TUBELESS TIRE REPAIR			
			
TubiMaster Plus II Special Edition Page 23	TubiPod Max Page 25	TubiCartridge R16 Page 27	TubiCartridge G16 Page 27



TOOL SERIES

CHAIN TOOL	SPEED WRENCH		
			
Super Chain Tool 13S Page 34	YHex Speed Wrench 2 / 2.5 / 3mm Page 35	YHex Speed Wrench 4 / 5 / 6mm Page 35	YTorx Speed Wrench T10 / T25 / T30 Page 36



DUO FIXER SYSTEM SERIES

TUBELESS TIRE REPAIR	TIRE INFLATION		LIGHT
			
TubiMaster GX DF Page 47	HybridMaster Mini Page 53	NanoMaster DF Page 48	TailLux 40 DF Page 49

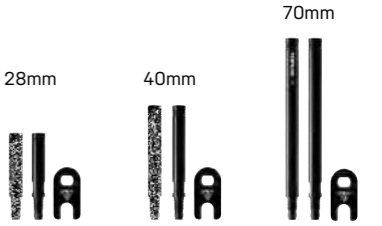





CO₂ INFLATOR & CARTRIDGE SHELL

CO ₂ INFLATOR & CARTRIDGE SHELL		2-PIECE TYPE VALVE EXTENDER		
				
Nano AirBooster Page 19	Nano AirBooster With CO ₂ Cartridge & Shell Page 19	CO ₂ Cartridge Shell Page 20		Valve Extender Page 21

TORQUE TOOLS

TORQUE TOOLS		STEALTH
		
Torq Stick Pro 4-20 Nm Page 37	Torq Stick Pro 2-10 Nm Page 39	Bar 'n Tool Combo Page 41

LIGHT

LIGHT	FENDER	FIXER	STRAP TYPE PACK
			
TailLux 25 DF Page 50	FlashFender DF Deluxe Page 51	FlashFender DF Black Page 52	Duo Fixer Page 45
			
		FlashFender DF Transparent Page 52	FreePack Page 55

BAG SERIES

BIKEPACKING (REAR)		REAR
<p>10L Green</p> <p>Black</p>	<p>15L Green</p> <p>Black</p>	<p>BackLoader Wishbone Page 61</p> <p>E-Explorer TrunkBag Page 63</p>

BOTTLE CAGE SERIES

KEVLAR CARBON					
R10		G12		MT16	
Blue	Red	Blue	Red	Blue	Red
Fezā Cage Kevlar Carbon R10 Page 79		Fezā Cage Kevlar Carbon G12 Page 79		Fezā Cage Kevlar Carbon MT16 Page 79	

WATER BOTTLE SERIES

650 ml / 22 oz		750 ml / 25 oz	
Black	White	Black	White
TTi® Bottle Page 83			

STAND SERIES

REPAIR	BIKE FRAME CLAMP
<p>PrepStand eUP Pro Page 69</p>	<p>Bike Truss 3X Page 71</p>

TUBE	WALLET	BIKE BELL
<p>GearPack Page 65</p>	<p>Large Medium Small</p> <p>PakGo® Wallet Page 67</p>	<p>UTF BellOnSide Page 86</p>

TUBULAR CARBON			AIRTAG ACCESSORIES		
R10	G12	MT16			
Black	Black	Black			
Fezā Cage Tubular Carbon Cage R10 Page 79	Fezā Cage Tubular Carbon Cage G12 Page 79	Fezā Cage Tubular Carbon Cage MT16 Page 79	Ninja+ Cage Z With AirTag Mount Page 81	Ninja+ CageMount For AirTag Page 81	CageMount For AirTag Page 81

RIDECASE & MOUNT SERIES

MOTORCYCLE MOUNT	BIKE MOUNT
<p>RideCase Mount HB with Omni RideCase Page 89</p> <p>RideCase Mount RM with Omni RideCase Page 90</p>	<p>Works with iPhone 13 Pro Max Works with iPhone 13 Pro Works with iPhone 13 Works with iPhone 13 Mini</p> <p>RideCase Page 91</p>

FENDER SERIES

ULTRALIGHT	FRONT	REAR
<p>FS DT ST</p> <p>S</p> <p>D-Flash Express Page 74</p>	<p>TetraFender M1 Page 76</p> <p>TetraFender M1 & M2 Set Page 76</p>	<p>TetraFender M2 Page 76</p> <p>TetraRack Fender M2 Page 78</p>



TRANSFORMER® 2STAGE

This unique 2-in-1 portable bike stand & floor pump combo comes with Topeak 2Stage pump technology, instantly delivering high volume air for MTB tire or switch to high pressure mode for gravel / road tire inflation with ease. Its built-in extendable long legs and adjustable non-marring QR hooks provides a stable platform to store or do light maintenance of any bikes including heavy duty bikes or ebikes.

HEAD	SmartHead® DX3 with air release button & extra-long hose	ATTACHMENT	Seat-chainstay
BARREL	Aluminum	MAX WEIGHT CAPACITY	30 kg / 66 lb
GAUGE	160 psi / 11 bar, Top mount, 360° rotating / dual analog Stage 1 2.3" gauge : 40 psi / 2.8 bar Stage 2 2.8" gauge : 160 psi / 11 bar	ADDED FEATURES	Dunlop valve adapter, Ball / bladder heads, Hose dock, Non-marring / adjustable rubber frame hooks, Foldable legs
VOLUME PER STROKE	Stage 1 - High Volume (756 cc) Stage 2 - High Pressure (273 cc)	SIZE	74 x 25 x 20.2 cm / 29.1" x 9.8" x 7.95" (Folded) 74 x 48.4 x 38.9 cm / 29.1" x 19.1" x 15.3" (Open)
HANDLE	Oversize padded / Dual density polymer	WEIGHT	2.4 kg / 5.29 lb
STAND	6061 T6 Tubes	ART NO.	TTF-EUP-2STG

SMARTHEAD + 2STAGE TECHNOLOGIES

2 STAGE Delivers both high volume and high pressure in record time.

360° Rotating / Dual Analog Gauges

360° ROTATE GAUGE TO SWITCH BETWEEN STAGE MODES

Stage 1 : High Volume (40 psi)

Stage 2 : High Pressure (160 psi)

756cc (per stroke)

273cc (per stroke)

STAGE 1 HIGH VOLUME

STAGE 2 HIGH PRESSURE

160 psi

40

0



Compact - Stable - Portable Bike Stand / Floor Pump - Bike Maintenance Station

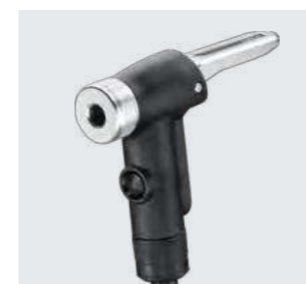

SmartHead® DX3



Adjustable, Rubber Padded Aluminum Hooks with QR Levers



Large Stable Base



Compact, stable and portable bike stand/floor pump combo for maintaining and storing your bike



TRANSFORMER® eUP

Stable and portable bike stand/floor pump combo for maintenance and storage of your bike. An extra-long pump hose reaches the front wheel easily. It features QR levers speed positioning of frame hooks to fit chainstays / seatstays and provide rear wheel lift. Non-marring rubber frame hooks won't harm bike's finish and the stronger, larger base adds stability that's perfect for e-Bikes, heavy weight bikes, and larger bike frames. This compact and dual function design stand/pump is the perfect assistant for your bike storage and repair/maintenance needs.

HEAD	TwinHead® DX5, Presta / Schrader / Dunlop valves with extra-long hose	ATTACHMENT	Seat-chainstay
BARREL	Aluminum	MAX WEIGHT CAPACITY	30 kg / 66 lb
GAUGE	160 psi / 11 bar, 3" top-mounted analog dual scale	ADDED FEATURES	Ball / bladder heads, Hose dock, Non-marring / adjustable rubber frame hooks, Foldable legs
VOLUME PER STROKE	341 cc	SIZE	69.5 x 25 x 19.2 cm / (Folded) 74 x 48.7 x 39.5 cm (Open)
HANDLE	Oversize padded / Dual density polymer	WEIGHT	2 kg / 4.41 lb
STAND	6061 T6 Tubes	ART NO.	TTF-EUP

TWINHEAD TECHNOLOGY



3", Easy-to-read, Top-mounted Analog Dual Scale Precision Gauge



Hammer Type TwinHead® DX5



Adjustable, Rubber Padded Aluminum Hooks with QR Levers



Large Stable Base

Air Release Button



Air release button for precise inflation control (works with Schrader valve only)

Large LCD Display



Stage 1 / Stage 2 Selector

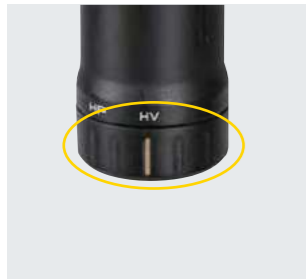

Valve Mode Selection

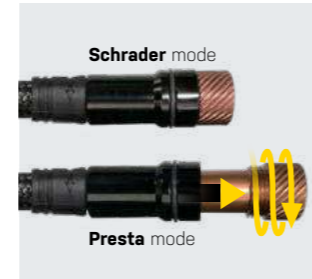

SmartHead® ThreadLock works with Presta and Schrader

Durable, Flexible and Braided Hose



MOUNTAIN 2STAGE DIGITAL

The Mountain 2Stage Digital shock pump features an innovative 2Stage pressure selector that lets you choose high pressure for filling suspension forks and shock units or high volume for inflating mountain bike tires. Integrated easy-to-read digital gauge provides accurate pressure readings up to 300psi / 20.7bar. A Pressure-Rite connector accepts Presta and Schrader valves while the flexible hose takes stress off valve stems when inflating tires. The air release button makes setting proper pressure quick and easy.

HEAD	SmartHead® ThreadLock, Pressure-Rite valve	VOLUME PER STROKE	Stage 1 - High Volume (84 cc / Tires) Stage 2 - High Pressure (11.2 cc / Shocks)
BARREL	Aluminum	PRESSURE TUNING	Air release button
GAUGE	300 psi / 20.7 bar, Digital Stage 1 - High Volume Stage 2 - High Pressure	SIZE	26 x 4.7 x 3.5 cm / 10.2" x 1.85" x 1.46"
UNIT	psi, bar, kg / cm ²	WEIGHT	210 g / 7.41 oz
BATTERY	CR2032 x 1 (included)	ART NO.	TMTD-2STG

2STAGE + SMARTHEAD THREADLOCK + PRESSURE-RITE TECHNOLOGIES



Delivers both high volume and high pressure in record time.



Stage 1 : High Volume
(0 - 30 psi)
(recommended)



Stage 2 : High Pressure
(30 - 300 psi)
(recommended)

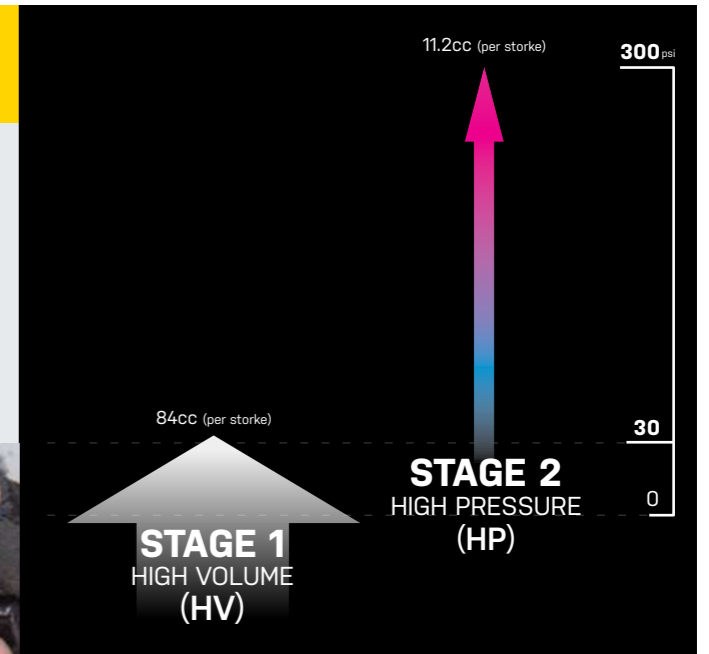

Pressure-Rite connector makes setting proper pressure easy and eliminates air loss when disconnecting.



TIRE

Fill suspension forks, shock units, and tires with the same ultra-precise digital shock pump



FORK



SHOCK



Presta Valve with Dust Cap



Integrated dust cap keeps head clean and ready for use

Aluminum Thumb Lock Lever



Aluminum thumb lock lever ensures air-tight seal

Stage 1 / Stage 2 Selector



Side Mount Bracket Included



GRAVEL 2STAGE

The Gravel 2Stage mini pump features an innovative 2Stage pressure selector that lets you choose high volume or high pressure to quickly fill your gravel bike tire effortlessly. Compact size easily fits into a jersey pocket.

HEAD	Presta valve with thumb lock & integrated dust cap
BARREL	Aluminum
CAPACITY	90 psi / 6 bar Stage 1 - 0 - 60 psi Stage 2 - 60 - 90 psi
VOLUME PER STROKE	Stage 1 - High Volume (71 cc) Stage 2 - High Pressure (24.8 cc)
HANDLE	Aluminum
ADDED FEATURE	Side mount bracket (Art No. TDP-2C)
SIZE	18.4 x 3.6 x 2.8 cm / 7.2" x 1.4" x 1.1"
WEIGHT	101 g / 3.56 oz
ART NO.	TGV-2STG

2STAGE TECHNOLOGY



Delivers both high volume and high pressure in record time.



Stage 1 : High Volume
(0 - 60 psi)



Stage 2 : High Pressure
(60 - 90 psi)

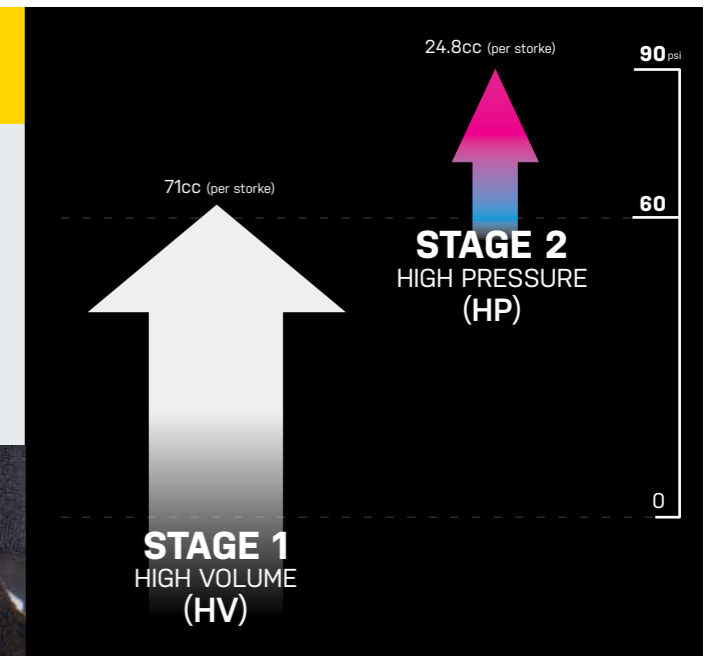

2Stage mini pump delivers high volume or high pressure to quickly fill gravel tires



Presta Valve with Dust Cap



Integrated dust cap keeps head clean and ready for use

Aluminum Thumb Lock Lever



Aluminum thumb lock lever ensures air-tight seal

Stage 1 / Stage 2 Selector

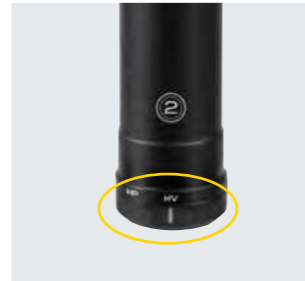

Side Mount Bracket Included



ROADIE 2STAGE

The Roadie 2Stage mini pump features an innovative 2Stage pressure selector that lets you choose high volume or high pressure to quickly fill your road bike tire effortlessly. Compact size easily fits into a jersey pocket.

HEAD	Presta valve with thumb lock & integrated dust cap	HANDLE	Aluminum
BARREL	Aluminum	ADDED FEATURE	Side mount bracket (Art No. TRK-PC01)
CAPACITY	160 psi / 11 bar Stage 1 - 0 - 75 psi Stage 2 - 75 - 160 psi	SIZE	16.2 x 3.2 x 2.5 cm / 6.4" x 1.26" x 1"
VOLUME PER STROKE	Stage 1 - High Volume (40.8 cc) Stage 2 - High Pressure (11.2 cc)	WEIGHT	89 g / 3.14 oz
		ART NO.	TRD-2STG

2STAGE TECHNOLOGY



Delivers both high volume and high pressure in record time.



Stage 1 : High Volume (0 - 75 psi)



Stage 2 : High Pressure (75 - 160 psi)

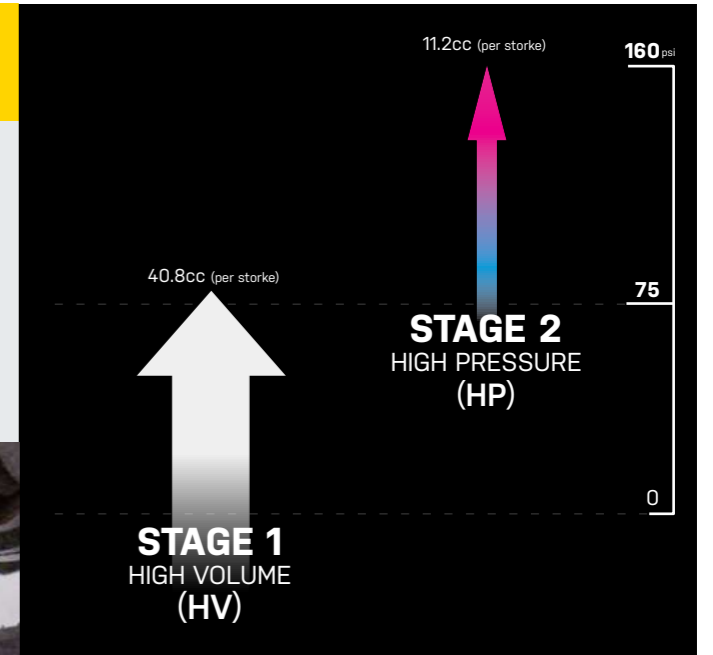

2Stage mini pump delivers high volume or high pressure to quickly fill road tires



HYBRIDROCKET HP MINI

HybridRocket technology combines the reliability of a mini pump with the rapid tire filling ability of a CO₂ inflator in a single unit. Designed for the high performance road rider, the HybridRocket HP Mini lets you quickly rejoin the group after fixing a flat. The extra compact pump and integrated CO₂ inflator lets you choose between pumping, inflating with CO₂ or a combination of both, and once you're finished, it fits neatly in your jersey pocket.

HEAD	SmartHead® ThreadLock with integrated dust cap
BARREL	CNC aluminum
CAPACITY	160 psi / 11 bar
VOLUME PER STROKE	17.5 cc
HANDLE	Aluminum / Dual density polymer
ADDED FEATURES	PCT Cap (Presta Core Tool Cap), 1 threaded 16g CO ₂ cartridge* included, Dust caps, Side mount bracket (Art No. TRK-PC05)
SIZE	16 x 3.9 x 2.35 cm / 6.3" x 1.5" x 0.9"
WEIGHT	88 g / 3.10 oz
ART NO.	THR-HPM1B

SMARTHEAD TECHNOLOGY

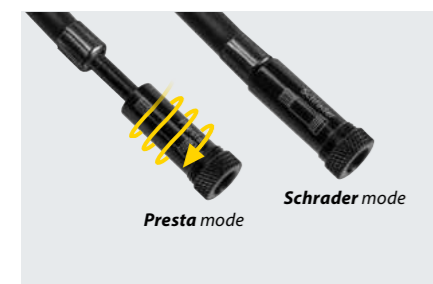

SmartHead® ThreadLock threads directly to Presta and Schrader valves with no need to change internal parts or use extra adaptors

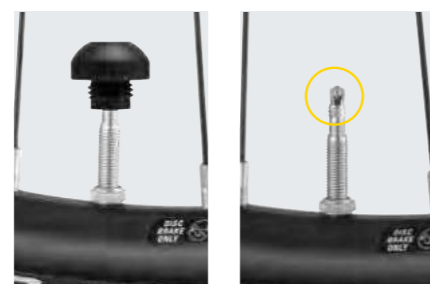

Built-in tool (PCT Cap) to tighten or remove two-piece Presta valve cores



Side mount bracket included



Use as a **CO₂ inflator** to get tires up to pressure fast



Use as a **mini pump** to continue inflating tire to the desired pressure or when cartridges are exhausted



Comes with side mount bracket allowing pump and CO₂ cartridge to be mounted on bike



Extra compact fits neatly in your jersey pocket

NANO AIRBOOSTER

An extremely compact, lightweight and easy-to-use CO₂ inflator. Precision CNC machined aluminum inflator fits Presta and Schrader valves and works with threaded 16g or 25g cartridges. Simply screw the cartridge in tight and then screw the head onto the valve, unscrew the cartridge to release all the gas from the CO₂ cartridge in seconds. Included CO₂ Cartridge Shell protects your hands from cold cartridges during inflation.

HEAD	Presta / Schrader valves
MATERIAL	CNC aluminum
ADDED FEATURES	1pc threaded 16g or 25g CO ₂ cartridge and shell included
SIZE	2.8 x 1.5 x 1.5 cm / 1.1" x 0.59" x 0.59"
WEIGHT	8.2 g / 0.29 oz (w/o CO ₂ cartridge)
ART NO.	TNAB-1 (Inflator head only) TNAB-16 (with 16g CO ₂ cartridge and shell) TNAB-25 (with 25g CO ₂ cartridge and shell)



CO₂ CARTRIDGE SHELL

Lightweight and durable 16g / 25g CO₂ Cartridge Shell protects your hands from cold cartridges during inflation.

MATERIAL	Engineering grade polymer / O-ring
SIZE	6.4 x 2.5 x 2.5 cm / 2.5" x 1" x 1" (16g) 7.8 x 2.9 x 2.9 / 3.1" x 1.14" x 1.14" (25g)
WEIGHT	5 g / 0.18 oz (16g / 1pc) 7 g / 0.25 oz (25g / 1pc)
ART NO.	TCSH-16 (2 pcs / set) TCSH-25 (2 pcs / set)



1. Quickly and securely thread CO₂ cartridge into Nano AirBooster



2. Hold Nano AirBooster and unthread CO₂ Cartridge 1/2 turn to inflate tire



CO₂ Cartridge Shell protects your hands from cold cartridges during inflation (Nano AirBooster & CO₂ cartridge available separately)



16g version fits Tubi Master X perfectly



Precision CNC machined aluminum inflator fits Presta and Schrader valves



An extremely compact and lightweight CO₂ inflator



Dual function use with Plug Insertion Tool to repair and inflate tubeless tires in one quick step (Plug Insertion Tool Kit available separately)

* Use only Topeak CO₂ cartridges

* Use only Topeak CO₂ cartridges

VALVE EXTENDER

For two-piece type Presta valves

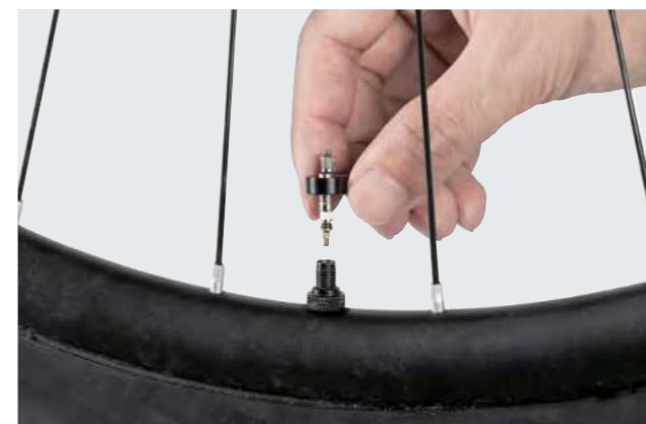

Use Valve Tool to remove Presta valve core



Use Valve Tool to tighten valve extender



Use Valve Tool to tighten Presta valve core



Provides additional Presta valve length of 28 / 40 / 70mm to aid inflation

VALVE EXTENDER

Machined from durable aircraft grade aluminum alloy to conveniently extend length of two-piece type Presta valves by 28 / 40 / 70mm to aid inflation. Durable aluminum alloy valve tool is designed to easily tighten or remove two-piece type Presta valve cores and valve extenders.

CONTENTS	2pcs auminum alloy valve extenders	WEIGHT	1.4 g / 0.05 oz (28mm)
	1pc aluminum alloy valve tool		1.8 g / 0.06 oz (40mm)
SIZE	3.8 x 0.6 x 0.6 cm / 1.5" x 0.23" x 0.23" (28mm)	ART NO.	TFV-05 (28mm)
	5 x 0.6 x 0.6 cm / 1.96" x 0.23" x 0.23" (40mm)		TFV-06 (40mm)
	8 x 0.6 x 0.6 cm / 3.15" x 0.23" x 0.23" (70mm)		TFV-07 (70mm)

TUBIMASTER PLUS II SPECIAL EDITION

A compact, all-in-one tubeless tire repair kit and CO₂ inflator makes quick work of repairing flats on the road or trail. CO₂ inflator head fits Presta valves and carries a single threaded 16g or 25g CO₂ cartridge. The Tire reamer and two sizes of plug insertion tools (1.5mm / 3.5mm) fold away into the tool body while a special concealed compartment holds two sizes of tire repair plugs. The mounting module with grip strap and zip ties allows the TubiMaster Plus to be attached to bike frames with ease.

TOOLS	CO ₂ inflator, one 25g CO ₂ cartridge, 2-in-1 tire reamers with 1.5mm & 3.5mm plug insertion tools, plug retainer, and knife with holder and dust cap
INFLATOR HEAD	CNC aluminum Fits Presta valves only (with dust cap)
TOOL MATERIAL	Chrome vanadium steel
ATTACHMENT	Mounting module with grip strap or zip ties
MOUNT	Bike frame
ADDED FEATURES	Safety lock for CO ₂ cartridge, plug insertion tool lock, repair plug compartment, mounting module with grip strap and zip ties, and 3 pieces each of 1.5mm x 50mm and 3.5mm x 50mm tire repair plugs included
SIZE	14.8 x 5.3 x 2.6 cm / 5.8" x 2.1" x 1" (w/o mounting module)
WEIGHT	246.5 g / 8.69 oz (w/ 25g CO ₂ cartridge & strap)
ART NO.	TUB-MP2-SE



MULTIPLE MOUNTING POSITIONS

Attach to seatpost or frame tube with mounting module and grip strap or zip ties



ALL-IN-ONE tubeless tire repair and CO₂ inflation kit

1.5mm / 3.5mm Plug Insertion Tools and tire repair plugs included

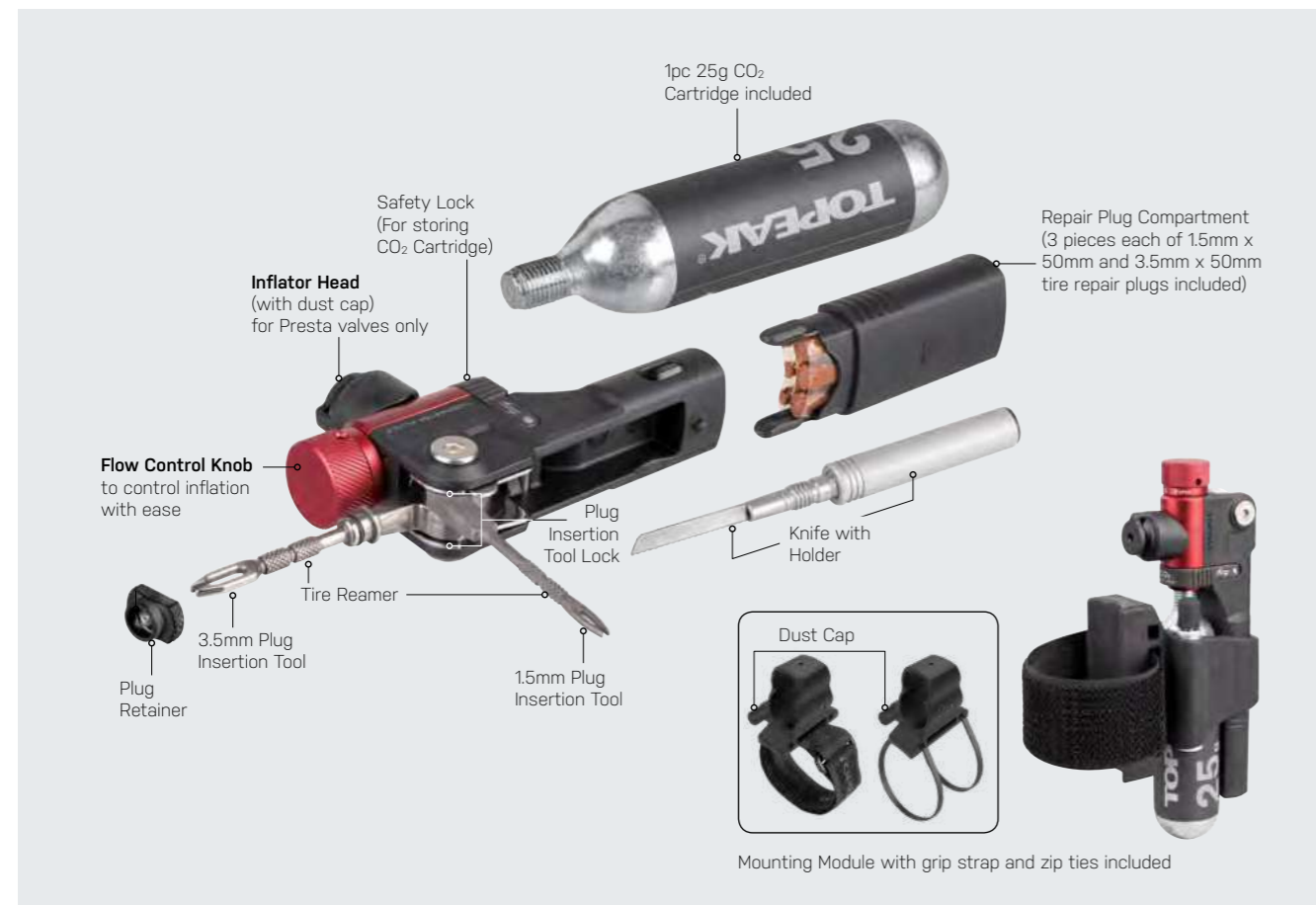

* Use only Topeak CO₂ cartridges



1. Insert 1.5mm or 3.5mm Plug Insertion Tool to seal hole



2. Remove excess plug with knife



3. Extend the Safety Lock to thread CO₂ cartridge into Inflater Head



4. Release Flow Control Knob to control inflation speed

* Empty any remaining CO₂ gas from the cartridge before removing it from TubiMaster Plus

TUBIPOD MAX

A complete tubeless tire repair / CO₂ inflation kit for mountain bikes. Tubeless repair tools are integrated into the pod end caps that feature knurled surfaces delivering extra grip when repairing tires. Included three tire plugs store inside a machined alloy pod, knife with holder and a Nano AirBooster with 25g CO₂ cartridge secures to a mounting module that can be strapped to a frame tube or seatpost.

TOOLS	Nano AirBooster CO ₂ inflator, one 25g CO ₂ cartridge, Tubi Pod, and knife
TOOL MATERIAL	Stainless steel
POD MATERIAL	Aluminum
ATTACHMENT	Adjustable nylon strap
MOUNT	Seatpost, bike frame, tubes
ADDED FEATURES	Knife holder with dust cap, repair plug compartment, mounting module with strap
SIZE	12.8 x 6.5 x 3.2 cm / 5" x 2.6" x 1.26" (w/o mounting strap)
WEIGHT	192.5 g / 6.79 oz (w/ 25g CO ₂ cartridge & strap)
ART NO.	TUB-PDM



MULTIPLE MOUNTING POSITIONS

Attach to seatpost or frame tube with mounting module and grip strap



* Use only Topeak CO₂ cartridges

ALL-IN-ONE tubeless tire repair and CO₂ inflation kit

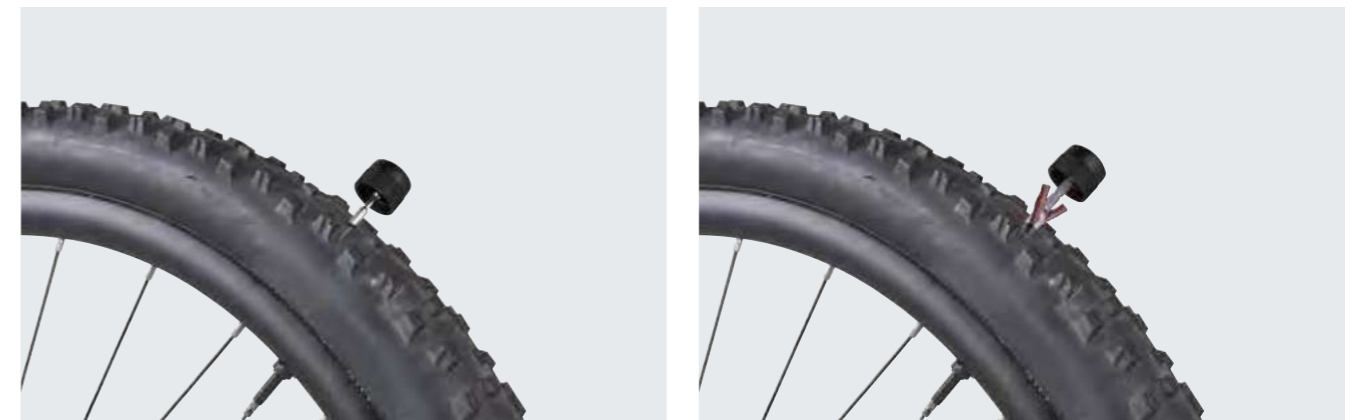

1. Air-stop tool prevents tire pressure loss when repairing puncture

2. Tire Plug Insertion Tool installs tire repair plug for a quick fix



3. Hold Nano AirBooster and unthread CO₂ Cartridge 1/2 turn to inflate tire



4. Remove excess plug with knife



TUBICARTRIDGE R16

A road bike tubeless tire repair kit stored compactly in a CO₂ cartridge style pod used alone for tire repairs or additionally with CO₂ inflator for tire inflation. Mount to saddle rails or bike frame with HybridMaster Mini, TubiMaster GX DF, NanoMaster DF, or TubiMaster GXT Bolt-on for a complete tubeless tire repair and/or inflation solution.

TOOLS	Stainless steel 1.5mm plug insertion tool and 5 pieces of 1.5mm x 50mm tire repair plugs
MATERIAL	CNC aluminum / Stainless steel
COMPATIBILITY	HybridMaster Mini, TubiMaster GX DF, NanoMaster DF, TubiMaster GXT Bolt-on, Ninja CO2, and Ninja Master+ CO2 FuelPack
ADDED FEATURE	Repair plug compartment
SIZE	8.8 x 2.2 x 2.2 cm / 3.5" x 0.9" x 0.9"
WEIGHT	34.3 g / 1.21 oz
ART NO.	TUB-CRD



TUBICARTRIDGE G16

A gravel bike tubeless tire repair kit stored compactly in a CO₂ cartridge style pod used alone for tire repairs or additionally with CO₂ inflator for tire inflation. Mount to saddle rails or bike frame with HybridMaster Mini, TubiMaster GX DF, NanoMaster DF, or TubiMaster GXT Bolt-on for a complete tubeless tire repair and/or inflation solution.

TOOLS	2-in-1 tire reamer / 3.5mm plug insertion tool and 5 pieces of 3.5mm x 50mm tire repair plugs
MATERIAL	CNC aluminum / Stainless steel
COMPATIBILITY	HybridMaster Mini, TubiMaster GX DF, NanoMaster DF, TubiMaster GXT Bolt-on, Ninja CO2, and Ninja Master+ CO2 FuelPack
ADDED FEATURE	Repair plug compartment
SIZE	8.8 x 2.2 x 2.2 cm / 3.5" x 0.9" x 0.9"
WEIGHT	38.3 g / 1.35 oz
ART NO.	TUB-CG



TUBICARTRIDGE MT25

A MTB tubeless tire repair kit stored compactly in a CO₂ cartridge style pod used alone for tire repairs or additionally with CO₂ inflator for tire inflation.

TOOLS	2-in-1 tire reamer / 3.5mm plug insertion tool and 5 pieces of 3.5mm x 50mm tire repair plugs
MATERIAL	CNC aluminum / Stainless steel
COMPATIBILITY	TubiMaster GXT Bolt-on
ADDED FEATURE	Repair plug compartment
SIZE	10.5 x 2.6 x 2.6 cm / 4.1" x 1" x 1"
WEIGHT	53.8 g / 1.90 oz
ART NO.	TUB-CMT



R16 with 1.5mm Plug Kit



1.5mm Plug Kit



1.5mm plug insertion tool used with the CO₂ cartridge type pod for tubeless tire repair

G16 / MT25 with 3.5mm Plug Kit



3.5mm Plug Kit



1.5mm plug insertion tool additional used with CO₂ inflator for tubeless tire repair and inflation (* Nano AirBooster, CO2 Cartridge Shell & CO₂ cartridge not included)

3.5mm Plug Kit



3.5mm plug insertion tool used with the CO₂ cartridge type pod for tubeless tire repair



3.5mm plug insertion tool additional used with CO₂ inflator for tubeless tire repair and inflation (* Nano AirBooster, CO2 Cartridge Shell & CO₂ cartridge not included)



R16 / G16 mounts to saddle rails with **TubiMaster GX DF** or **NanoMaster DF** for a complete tubeless tire repair and/or inflation solution



R16 / G16 mounts to saddle rails with **HybridMaster Mini** for a complete tubeless tire repair and/or inflation solution



R16 / G16 / MT25 mounts to bike frame with **TubiMaster GXT Bolt-on** for a complete tubeless tire repair / inflation solution

TUBIMASTER GXT BOLT-ON

Features one 9 function full metal folding tool, Nano AirBooster CO₂ inflator, 16g CO₂ cartridge, and TubiCartridge G16 which packs compactly to mount on frame, seatpost, or water bottle boss with included Frame Mount and zip ties. Easily accessed with a simple twist for a basic bike maintenance or tubeless tire repair and inflation.

TOOLS	9 function full metal folding tool - 2 / 2.5 / 3 / 4 / 5 / 6 / 8 mm Allen wrenches, T25 Torx® wrench, and flat head screw driver Nano AirBooster CO ₂ inflator, one 16g CO ₂ cartridge, TubiCartridge G16
INFLATOR HEAD	CNC aluminum Fits Presta / Schrader valves
MOUNT	Install on frame, seatpost, or water bottle boss with included Frame Mount and zip ties
SIZE	10.5 x 7.6 x 4.4 cm / 4.1" x 3" x 1.7"
WEIGHT	210 g / 7.41 oz
ART NO.	TUB-GXTBN

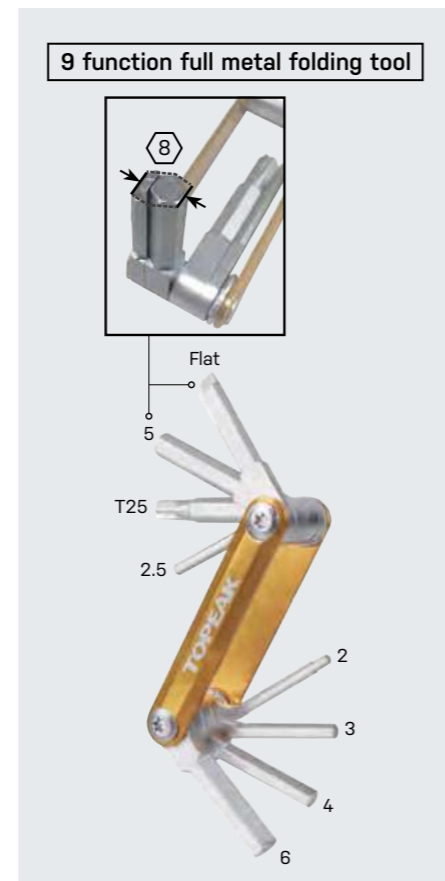

A compact frame mount tubeless tire repair and CO₂ inflation kit

TWO MOUNTING OPTIONS



MULTI-FUNCTION tubeless tire repair and CO₂ inflation kit

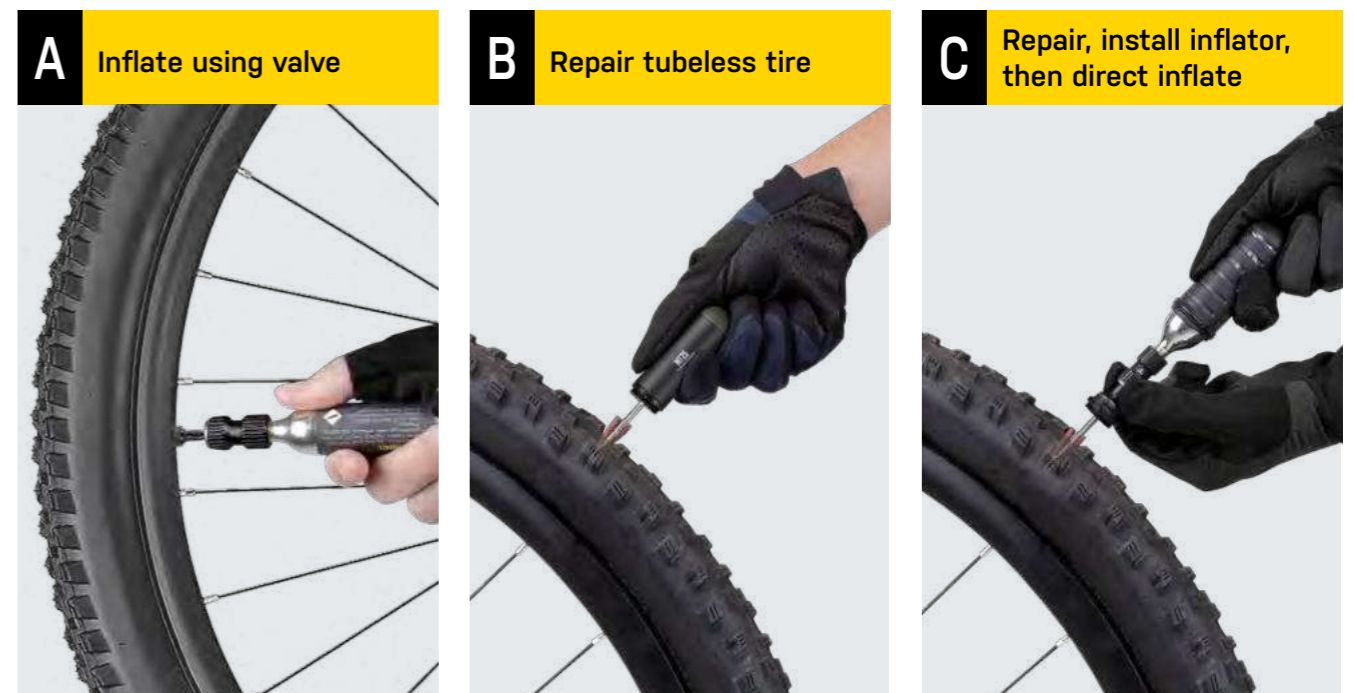

(* CO₂ Cartridge Shell not included)



TUBIMASTER RX

A compact frame tube mount, multi-function tubeless tire repair and CO₂ inflation kit features Nano AirBooster CO₂ inflator, TubiCartridge R16 and one 16g CO₂ cartridge for road bikes. Included mounting module with grip strap allows the TubiMaster RX to be attached to seatpost or bike frames with ease.

TOOLS	Nano AirBooster CO ₂ inflator, TubiCartridge R16, and one 16g CO ₂ cartridge
INFLATOR HEAD	CNC aluminum Fits Presta / Schrader valves
ATTACHMENT	Adjustable nylon strap
MOUNT	Seatpost, bike frame, tubes
ADDED FEATAURE	Mounting module with grip strap
SIZE	8.9 x 6.8 x 5.4 cm / 3.5" x 2.7" x 2.1"
WEIGHT	154 g / 5.43 oz
ART NO.	TUB-MSRX



TUBIMASTER MX

A compact frame tube mount, multi-function tubeless tire repair and CO₂ inflation kit features Nano AirBooster CO₂ inflator, TubiCartridge MT25 and one 25g CO₂ cartridge for MTB. Included mounting module with grip strap allows the TubiMaster MX to be attached to seatpost or bike frames with ease.

TOOLS	Nano AirBooster CO ₂ inflator, TubiCartridge MT25, and one 25g CO ₂ cartridge
INFLATOR HEAD	CNC aluminum Fits Presta / Schrader valves
ATTACHMENT	Adjustable nylon strap
MOUNT	Seatpost, bike frame, tubes
ADDED FEATAURE	Mounting module with grip strap
SIZE	10.5 x 7.3 x 6.1 cm / 4.1" x 2.9" x 2.4"
WEIGHT	225 g / 7.94 oz
ART NO.	TUB-MSMX

MULTIPLE MOUNTING POSITIONS

Attach to seatpost or frame tube with mounting module and grip strap



MULTI-FUNCTION tubeless tire repair and CO₂ inflation kit

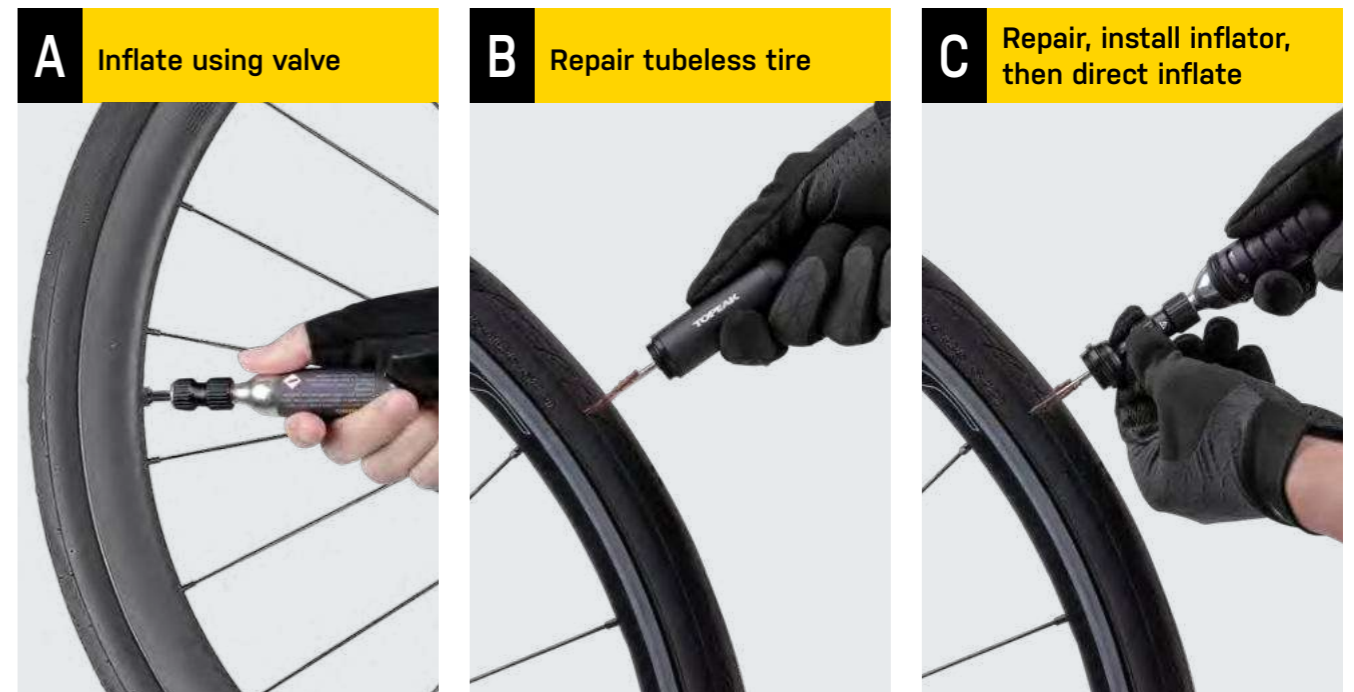

(* CO₂ Cartridge Shell not included)





No more clogged valve stems

TUBI VALVE CLEANER

Precision CNC machined aluminum Tubi Valve Cleaner allows to remove or tighten two-piece Presta valve core and clear tire sealant clogs from valve stem for tubeless tire maintenance. Compact size easily fits in a jersey pocket or saddle, or mount with TubiPod Max, TubiMaster Plus II Special Edition or TubiMaster MX / RX for a ride.

MATERIAL	CNC aluminum / Stainless steel
COMPATIBILITY	Allows to mount with TubiPod Max, TubiMaster Plus II Special Edition or TubiMaster MX / RX
ADDED FEATURE	PCT (Presta Core Tool)
SIZE	6.8 x 0.95 x 0.95 cm / 2.7" x 0.4" x 0.4"
WEIGHT	8.8 g / 0.31 oz
ART NO.	TUB-VC



Mounts to seatpost, bike frame, or tubes with TubiPod Max, TubiMaster Plus II Special Edition or TubiMaster MX / RX.

13
SPEED

SUPER CHAIN TOOL 13S

High quality, long service life, cast CrMo steel construction chain tool for single and multi-speed chains up to 13 speed, including Campagnolo® hollow pin chains. Built-in clip holds tool pieces together. Contains 4 and 5mm Allen wrenches and chain hook.

TOOLS	CrMo steel chain tool, 4 / 5 mm Allen wrenches, steel wire chain hook	SIZE	7.9 x 4.2 x 2.1 cm / 3.1" x 1.65" x 0.8"
TOOL MATERIAL	Hardened steel	WEIGHT	66 g / 2.33 oz
ADDED FEATURES	Chain hook holder, Chain pin holder & Chain pin breaker	ART NO.	TT2602

Compatible with single and multi-speed chains up to 13 speed, including Campagnolo® hollow pin chains.

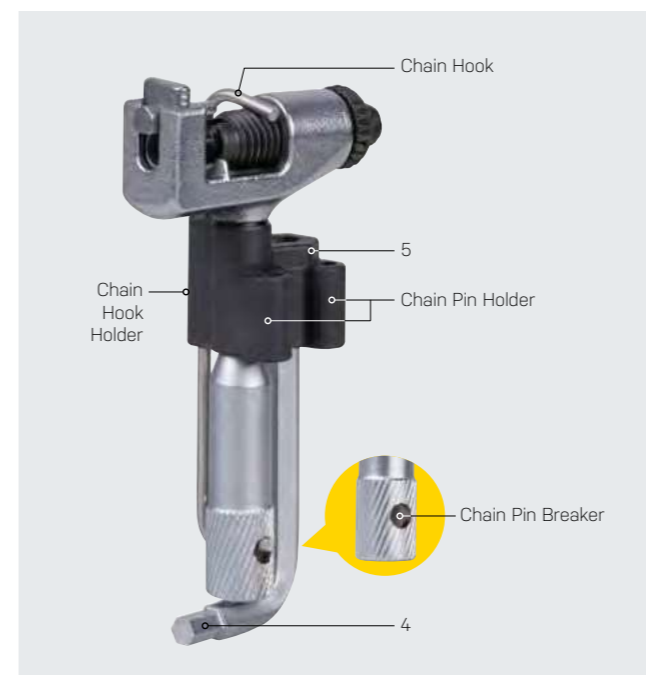

Built-in clip holds tool pieces together

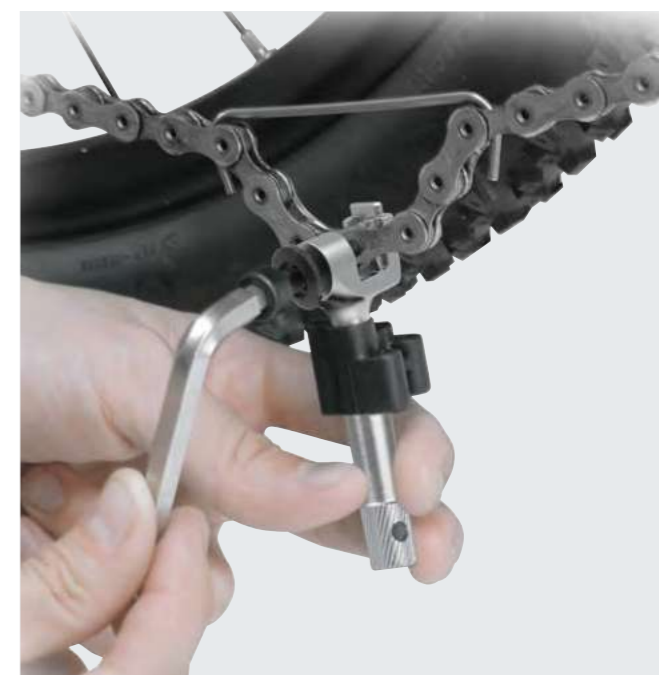

Integrated chain hook holds links during assembly

3-way Pro Quality Wrench

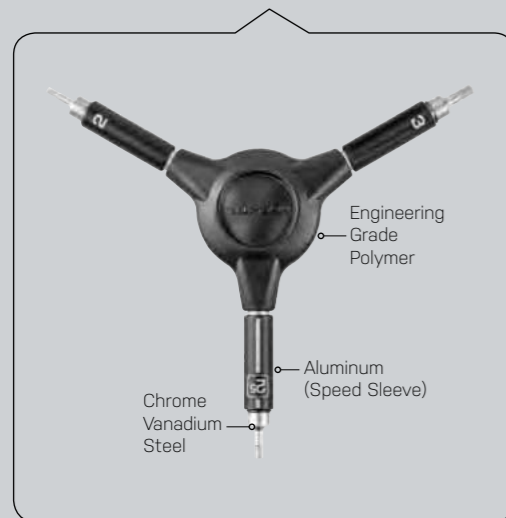

Color Coding



Speed Sleeve Adds Speed with Efficiency



Provides Excellent Leverage and Usage



YHex SPEED WRENCH 2/2.5/3mm

A 3-way pro quality, chrome vanadium steel 2/2.5/3mm hex wrench with high tensile strength for better wear resistance, extended tool life and provides excellent leverage and usage. Built-in speed sleeve adds speed with efficiency.

TOOLS	2 / 2.5 / 3 mm Allen bits
BIT MATERIAL	Chrome vanadium steel
BODY MATERIAL	Aluminum / Engineering grade polymer
ADDED FEATURE	Speed Sleeve
SIZE	13.8 x 12 x 1.7 cm / 5.4" x 4.7" x 0.67"
WEIGHT	86 g / 3.03 oz
ART NO.	TT2597

YHex SPEED WRENCH 4/5/6mm

A 3-way pro quality, chrome vanadium steel 4/5/6mm hex wrench with high tensile strength for better wear resistance, extended tool life and provides excellent leverage and usage. Built-in speed sleeve adds speed with efficiency. Color coded 4 / 5 / 6mm Allen wrenches for easy identification.

TOOLS	4 / 5 / 6 mm Allen bits
BIT MATERIAL	Chrome vanadium steel
BODY MATERIAL	Aluminum / Engineering grade polymer
ADDED FEATURE	Speed Sleeve, Color coding
SIZE	13.8 x 12 x 1.7 cm / 5.4" x 4.7" x 0.67"
WEIGHT	90 g / 3.17 oz
ART NO.	TT2598



YTorx SPEED WRENCH T10/T25/T30

A 3-way pro quality, chrome vanadium steel T10/T25/T30 Torx® wrench with high tensile strength for better wear resistance, extended tool life and provides excellent leverage and usage. Built-in speed sleeve adds speed with efficiency.

TOOLS	T10 / T25 / T30 Torx® bits
BIT MATERIAL	Chrome vanadium steel
BODY MATERIAL	Aluminum / Engineering grade polymer
ADDED FEATURE	Speed Sleeve
SIZE	13.8 x 12 x 1.7 cm / 5.4" x 4.7" x 0.67"
WEIGHT	88 g / 3.10 oz
ART NO.	TT2599



Grip Sleeve adds speed with efficiency

Suitable for tight spaces where standard wrenches won't fit



Reversible ratchet with thumb wheel action for quick rotation and control in tight spots

Magnetic holder secures bits and adds leverage

TORQ STICK PRO 4-20Nm

Torq Stick 4-20Nm Pro version. Torque wrench with adjustable preset range of 4-20Nm features a standard hex drive reversible ratcheting head and a fine tooth ratchet mechanism with reverse lever and thumb wheel for quick rotation and control in tight spots. Includes magnetic bit holder for adding leverage, fingertip bit holder for narrow space, and 18 tool bits with a generous 30mm length for reaching tough bolt locations. Knurling on the individual tool bits provides additional grip when changing or removing from the organizer and ratchet tool head. Fits neatly into a storage box.

FUNCTIONS 22

TOOLS 1.5 / 2 / 2.5 / 3 / 4 / 5 / 6 / 8 / 10mm Allen bits
T6 / T7 / T8 / T9 / T10 / T15 / T20 / T25 / T30 Torx® bits

TORQ RANGE 4 - 20 Nm

BIT MATERIAL S2 hardened steel

RATCHET TOOL MATERIAL Chrome vanadium steel

TORQUE WRENCH MATERIAL Hardened steel / Aluminum / Engineering grade polymer

ADDED FEATURES Two ratchet tools, two 9 bit organizers, Speed Sleeve Bit Holder, Finger Bit Holder, and storage box

SIZE 22.7 x 2.5 x 2.15 cm / 8.9" x 1" x 0.8" (Torque tool)
25 x 9 x 6 cm / 9.8" x 3.5" x 2.4" (Box)

WEIGHT 620 g / 21.87 oz

ART NO. TT2601

22 FUNCTIONS



Torq Stick 4-20Nm Ratchet Tool Speed Sleeve Bit Holder Finger Bit Holder 9 Torx® Bits 9 Allen Bits

Durable & Rugged Tool Box

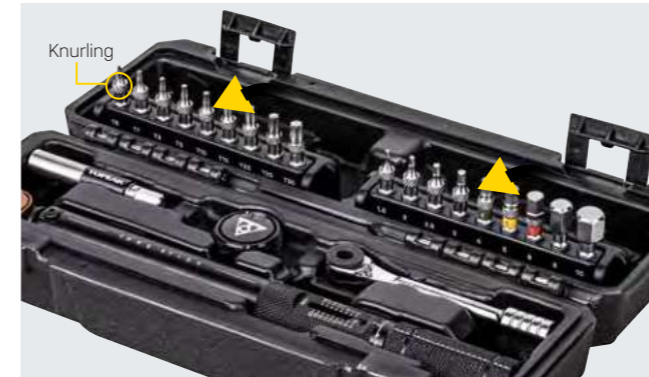

Handy flip-up organizer eases bit access and knurling makes bits easy to grasp and remove from organizer and ratchet tool head

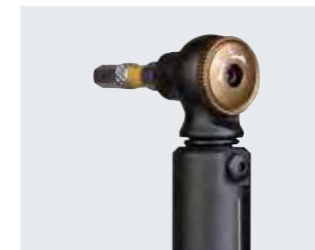

Reversible ratcheting head

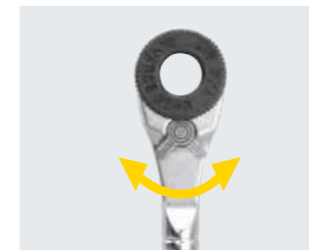

Reversible ratchet with thumb wheel action



Grip Sleeve adds speed with efficiency

Magnetic holder secures bits and adds leverage

The pro version provides multiple combination choice to repair or maintain your bike.



Torque wrench with adjustable preset range of 4 - 20Nm



Decrease Increase

Pull Down to Rotate

Rotate a half turn for 0.5Nm adjustment



Grip Sleeve adds speed with efficiency

Suitable for tight spaces where standard wrenches won't fit



30mm bit length makes it easy to reach sunken bolts / nuts for aero seatposts or caliper brakes

TORQ STICK PRO 2-10Nm

Torq Stick 2-10Nm Pro version. Torque wrench with adjustable preset range of 2-10Nm features a standard hex drive reversible ratcheting head. Includes magnetic bit holder for adding leverage, fingertip bit holder for narrow space, and 9 tool bits with a generous 30mm length for reaching tough bolt locations. Knurling on the individual tool bits provides additional grip when changing or removing from the organizer and ratchet tool head. Fits neatly into a storage box.

FUNCTIONS	12
TOOLS	2.5 / 3 / 4 / 5 / 6mm Allen bits T15 / T20 / T25 / T30 Torx® bits
TORQ RANGE	2 - 10 Nm
BIT MATERIAL	S2 hardened steel
TORQUE WRENCH MATERIAL	Hardened steel / Aluminum / Engineering grade polymer
ADDED FEATURES	Ratchet tool, 9 bit organizer, Speed Sleeve Bit Holder, Finger Bit Holder, and storage box
SIZE	15 x 2.5 x 2.15 cm / 5.8" x 1" x 0.85" (Torque tool) 17 x 9 x 6 cm / 6.7" x 3.5" x 2.4" (Box)
WEIGHT	390 g / 13.76 oz
ART NO.	TT2600



Handy flip-up organizer eases bit access



Knurling makes bits easy to grasp and remove from organizer and bit holder

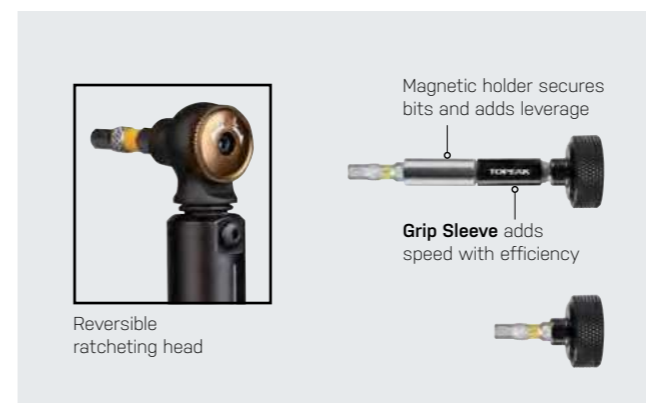

The pro version provides multiple combination choices to repair or maintain your bike.



Torque wrench with adjustable preset range of 2 - 10Nm

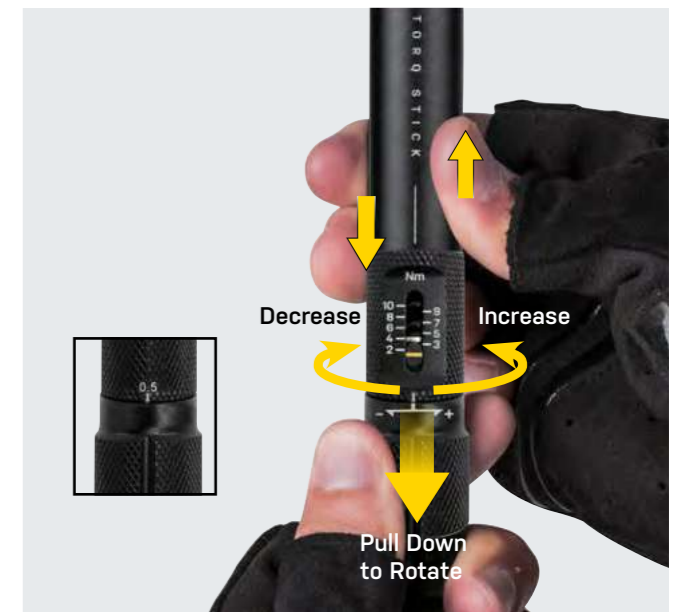

Rotate a half turn for 0.5Nm adjustment



Perfect fit for Ergon grips* with built-in bar ends

* Fits Ergon grips GS2 / GS3 / GP2 / GP3 / GP4 / GP5 series

BAR 'n TOOL COMBO

Compact and stealthy tools sneak inside the bar ends which are cleverly efficient for emergency use and perfect fit for Ergon grips with built-in bar ends. Includes foldable chain tool and 9 function full metal folding tool.

TOOLS	9 function full metal folding tool 2 / 2.5 / 3 / 4 / 5 / 6 / 8 mm Allen wrenches, T25 Torx* wrench, and flat head screw driver	COMPATIBILITY	Ergon grips GS2 / GS3 / GP2 / GP3 / GP4 / GP5 series and handlebars 22.2mm outer diameter (sizing shims included)
TOOL MATERIAL	Chrome vanadium steel	ADDED FEATURE	Rivet Anvil for use with Campagnolo® hollow pin
	Foldable aluminum chain tool Foldable chain tool with L-type 4mm Allen wrench and 2.5mm Allen wrench to self-tighten	SIZE	12 x 4 x 3.85 cm / 4.7" x 1.6" x 1.5" (Each bar end)
MOUNT	Handlebar ends	WEIGHT	xx
		ART NO.	TBT001



Compatible with handlebars 22.2mm outer diameter (sizing shims included)

Foldable aluminum chain tool

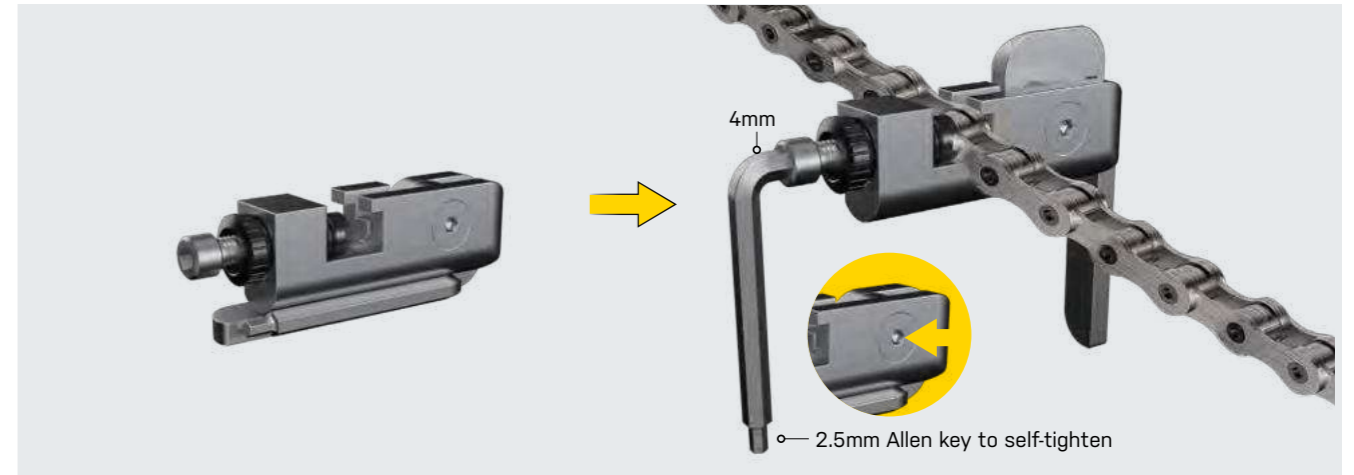

13
SPEED

Compatible with single and multi-speed chains up to 13 speed, including Campagnolo® hollow pin chains.

9 function full metal folding tool

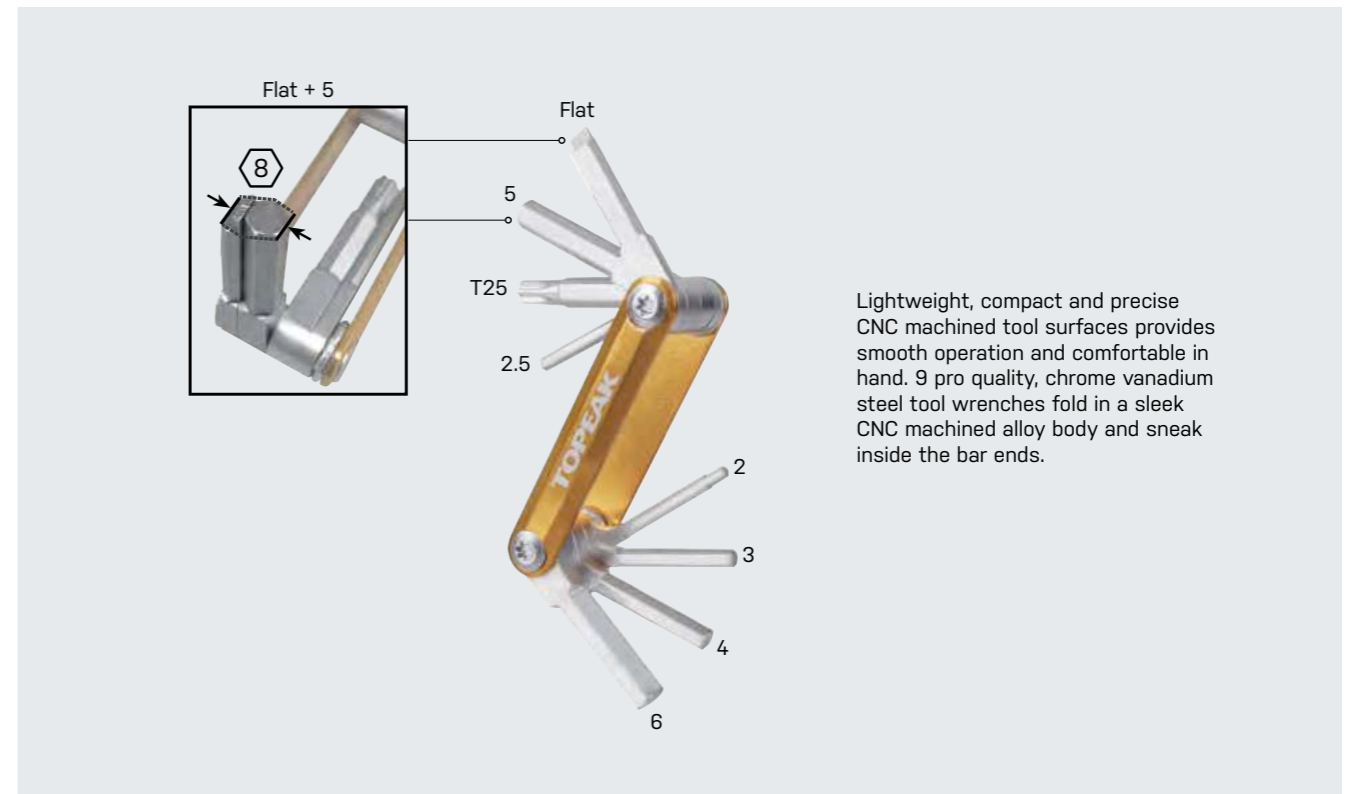

Lightweight, compact and precise CNC machined tool surfaces provides smooth operation and comfortable in hand. 9 pro quality, chrome vanadium steel tool wrenches fold in a sleek CNC machined alloy body and sneak inside the bar ends.



DUO FIXER MOUNTING SYSTEM

Introducing Duo Fixer system series that allows fast and easy tool-free mounting and removal of two separate accessories that are QuickClick equipped. The under saddle location provides a secure and clean look and can mount Tubi tools, CO₂ inflators, lights and fenders. A simple slide and click is all it takes to go on a safe and secure ride.



TUBELESS TIRE REPAIR & CO2 INFLATION KITS



TubiMaster GX DF



NanoMaster DF

SAFETY TAIL LIGHTS



TailLux 40 DF



TailLux 25 DF

MUD, RAIN PROTECTION FENDERS



FlashFender DF Deluxe



FlashFender DF Black



FlashFender DF Transparent

APPLICATIONS



UPPER DF SYSTEM PRODUCTS



FlashFender DF Black



FlashFender DF Transparent

LOWER COMPATIBLE PRODUCTS

CO₂ INFLATION KIT



HybridMaster Mini

TIRE REPAIR KIT



FreePack

FENDER



FlashFender DF Deluxe

SADDLE BAGS



Aero Wedge Pack series



Wedge Pack II series



SideKick Wedge Pack series

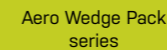

MondoPack series

QUICKCLICK SYSTEM



ProPack series



Weatherproof DynaWedge



DynaWedge

STRAP MOUNT SYSTEM

Duo Fixer +



Zinc Alloy Strap Mount (Required)





Included **Zinc Alloy Strap Mount** for the attachment of most strap type saddle bags (* Not compatible with buckle strap type saddle bags)

DUO FIXER

A saddle rail fixer that allows fast and easy tool-free mounting and removal of two separate accessories that are QuickClick equipped underneath the saddle cleanly and securely. Duo Fixer system allows to mount Topeak QuickClick saddle bags or most strap type saddle bags and provides dual use with Topeak Duo Fixer system accessories, including Tubi tools, CO₂ inflators, lights, and fenders. A simple slide and click is all it takes to go on a safe and secure ride.

MATERIAL	Engineering grade polymer / Zinc alloy
COMPATIBILITY	<p>Upper - TubiMaster GX DF, NanoMaster DF, TailLux DF lights, and FlashFender DF with upper bracket</p> <p>Lower - Topeak QuickClick or most strap type saddle bags, HybridMaster Mini, FreePack, and FlashFender DF with lower bracket</p> <p>Not compatible with monorail or spring type saddle rails</p>
ATTACHEMENT	Saddle rail
ADDED FEATURE	Zinc Alloy Strap Mount
WEIGHT	32 g / 1.13 oz
ART NO.	TDF01



Twice the function with Duo system

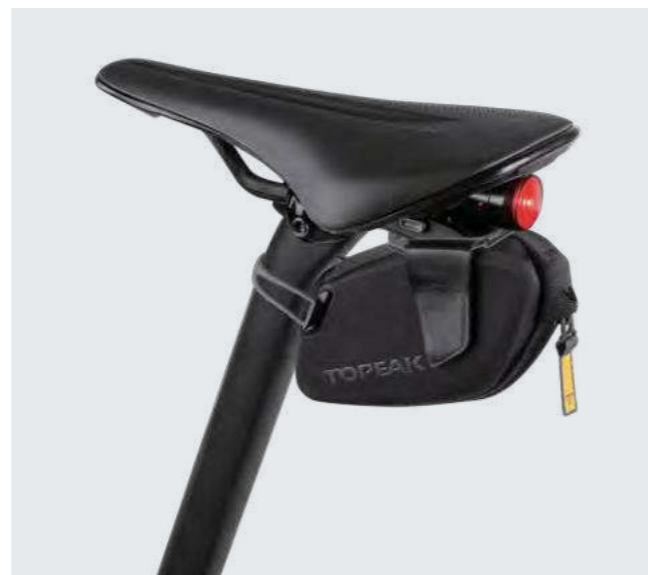

Additional Zinc strap mount provides an attachment point for **most strap type saddle bags** and double use with DF system accessories (* Not compatible with buckle strap type saddle bags)



Compatible with steel, CroMo, titanium, and carbon standard saddle rails with 36mm width spacing and at least 30mm height spacing (* Not compatible with monorail or spring type saddle rails)

DF APPLICATIONS

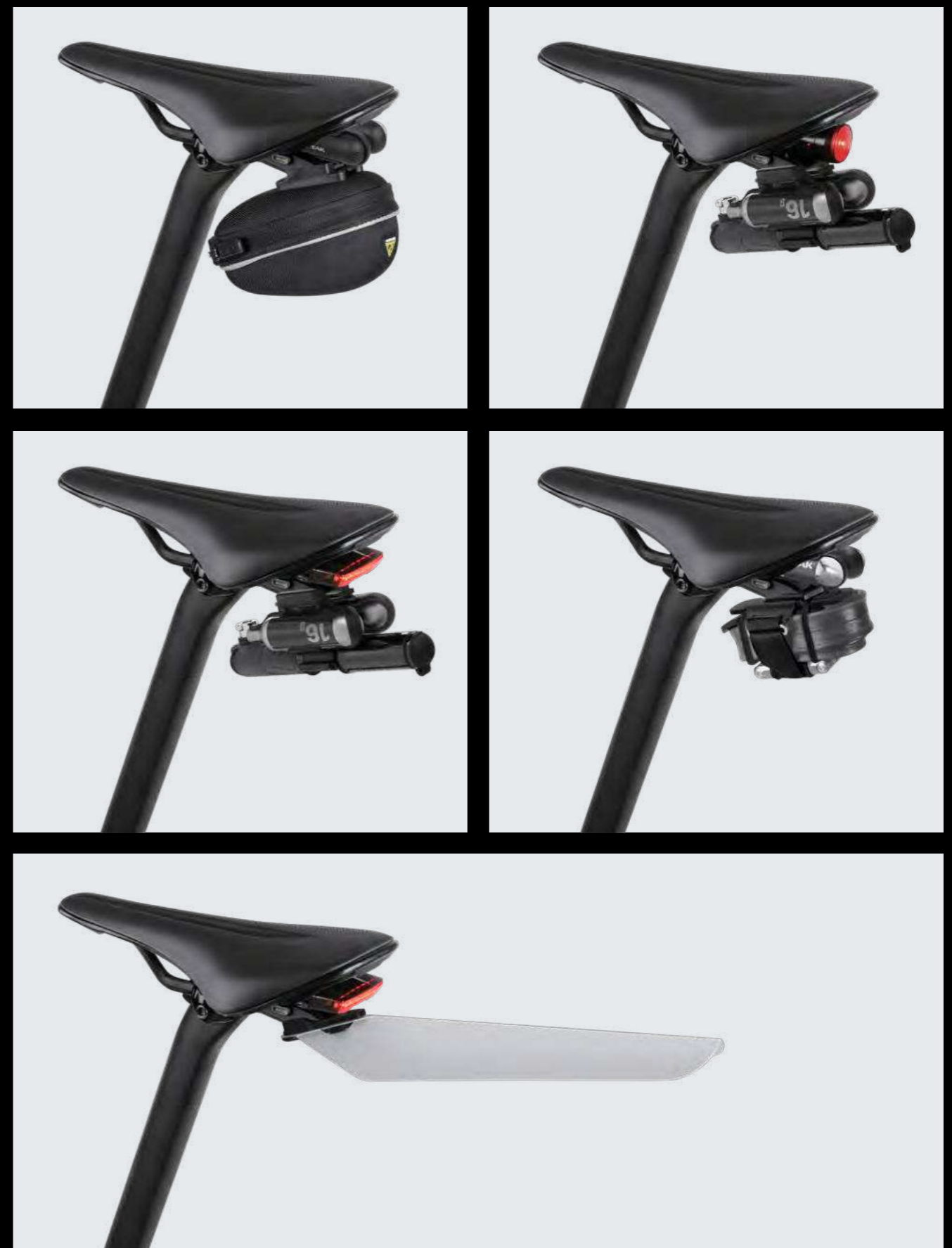

TUBIMASTER GX DF

Ultra compact, race ready tubeless tire repair and CO₂ inflation kit features a Nano AirBooster CO₂ inflator, TubiCartridge G16, and 16g CO₂ cartridge. Mounts to saddle rail with included Duo Fixer which provides dual use with Topeak Duo Fixer system accessories, including Topeak Duo Fixer QuickClick saddle bags, CO₂ inflators, lights, and fenders. A simple slide and click is all it takes to go on a safe and secure ride.

TOOLS	Nano AirBooster CO ₂ inflator, TubiCartridge G16, and one 16g CO ₂ cartridge
INFLATOR HEAD	CNC aluminum Fits Presta / Schrader valves
ATTACHMENT	Duo Fixer on saddle rail
COMPATIBILITY	Lower - Topeak QuickClick saddle bags, HybridMaster Mini, FreePack, and FlashFender DF with lower bracket
ADDED FEATURE	Mounting module
SIZE	11 x 4.7 x 3.6 cm / 4.3" x 1.85" x 1.4"
WEIGHT	128 g / 4.51 oz
ART NO.	TDF-TMGX

DUO FIXER TECHNOLOGY



Duo Fixer included



Duo Fixer included

NANOMASTER DF

Ultra compact CO₂ inflation kit features a Nano AirBooster CO₂ inflator and two 16g CO₂ cartridges. Mounts to saddle rail with included Duo Fixer which provides dual use with Topeak Duo Fixer system accessories, including Topeak QuickClick saddle bags, Tubi tools, CO₂ inflators, lights, and fenders. A simple slide and click is all it takes to go on a safe and secure ride.

TOOLS	Nano AirBooster CO ₂ inflator and two 16g CO ₂ cartridges
INFLATOR HEAD	CNC aluminum Fits Presta / Schrader valves
ATTACHMENT	Duo Fixer on saddle rail
COMPATIBILITY	Lower - Topeak QuickClick saddle bags, HybridMaster Mini, FreePack, and FlashFender DF with lower bracket
ADDED FEATURE	Mounting module
SIZE	11 x 4.7 x 3.6 cm / 4.3" x 1.85" x 1.4"
WEIGHT	149 g / 5.26 oz
ART NO.	TDF-NM

DUO FIXER TECHNOLOGY



Included Duo Fixer provides dual use with Topeak Duo Fixer system compatible products to carry even more essentials



Duo Fixer included

40 LUMENS (MAX)

Constant - 10 lm (3.5 hr)
Blink - 10 lm (40 hr)
Pulse - 40 lm (20 hr)

TAILLUX 40 DF

Compact, super bright red LED rear light provides 40 lumens and hides beneath the saddle with included Duo Fixer which allows fast and easy tool-free mounting and removal. It provides dual use with Topeak Duo Fixer system accessories, including Topeak QuickClick saddle bags, Tubi tools, CO₂ inflators, and fenders. Features convenient cable-free charging with a direct USB port plug.

MAX LUMINOUS INTENSITY	40 Lumens
LAMP	Super bright red LED's
BATTERY	3.7V 160mAh Lithium Ion (integrated)
CONTROL	3 modes
CHARGE / CHARGE TIME APPROX	USB-A / 2-3 hr
INPUT	5V 500mA
LAMP HOUSING	Engineering grade polymer
ATTACHMENT	Duo Fixer on saddle rail
COMPATIBILITY	Lower - Topeak QuickClick saddle bags, HybridMaster Mini, FreePack, and FlashFender DF with lower bracket
WATERPROOF	IPX 6
SIZE	6.6 x 3.5 x 2.7 cm / 2.6" x 1.4" x 1.1"
WEIGHT	30 g / 1.06 oz
ART NO.	TDF-TL40

DUO FIXER TECHNOLOGY

NO CHARGING CABLE REQUIRED

Simply plug light body directly into Type A USB port for charging



Included Duo Fixer provides dual use with Topeak Duo Fixer system compatible products to carry even more essentials



Duo Fixer included

25 LUMENS (MAX)

Constant - 10 lm (3.5 hr)
Blink - 10 lm (40 hr)
Pulse - 25 lm (30 hr)
Sequence - 12 lm (20 hr)

NO CHARGING CABLE REQUIRED

Simply plug light body directly into Type A USB port for charging



TAILLUX 25 DF

Compact, 8 super bright red LEDs rear light hides beneath the saddle with included Duo Fixer which allows fast and easy tool-free mounting and removal. It provides dual use with Topeak Duo Fixer system accessories, including Topeak QuickClick saddle bags, Tubi tools, CO₂ inflators, and fenders. Features convenient cable-free charging with a direct USB port plug.

MAX LUMINOUS INTENSITY	25 Lumens
LAMP	8 super bright red LED's
BATTERY	3.7V 200mAh Lithium Ion (integrated)
CONTROL	4 modes
CHARGE / CHARGE TIME APPROX	USB-A / 2-3 hr
INPUT	5V 500mA
LAMP HOUSING	Engineering grade polymer
ATTACHMENT	Duo Fixer on saddle rail
COMPATIBILITY	Lower - Topeak QuickClick saddle bags, HybridMaster Mini, FreePack, and FlashFender DF with lower bracket
WATERPROOF	IPX 6
SIZE	7 x 5.4 x 2.9 cm / 2.75" x 2.1" x 1.14"
WEIGHT	30 g / 1.06 oz
ART NO.	TDF-TL25

DUO FIXER TECHNOLOGY



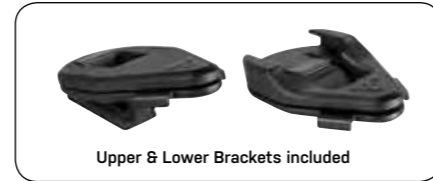

FLASHFENDER DF DELUXE

Durable polypropylene fender is ultralight, stylish, and simple to slide and click then ready to go when wet weather arrives. Included Duo Fixer allows fast and easy tool-free mounting and removal and provides dual use with Topeak Duo Fixer system accessories, including Topeak QuickClick saddle bags or most strap type saddle bags, Tubi tools, CO₂ inflators, and lights underneath the saddle. Black and transparent colors with exchangeable upper and lower brackets as a set for the color options and mounting position option to suit different needs.

MATERIAL	Polypropylene / Engineering grade polymer	ATTACHEMENT	Duo Fixer on saddle rail
COMPATIBILITY	Upper - TubiMaster GX DF, NanoMaster DF, TailLux DF lights, and FlashFender DF with upper bracket Lower - Topeak QuickClick saddle bags or most strap type saddle bags, HybridMaster Mini, FreePack, and FlashFender DF with lower bracket	SIZE	29 x 8.5 x 2.15 cm / 11.4" x 3.3" x 0.84" (Upper) 29 x 8.5 x 1.8 cm / 11.4" x 3.3" x 0.71" (Lower)
		WEIGHT	26 g / 0.92 oz (Upper), 22 g / 0.78 oz (Lower)
		ART NO.	TDF-FFD

DUO FIXER TECHNOLOGY



Transparent FlashFender provides double use with TailLux DF light for safety at night

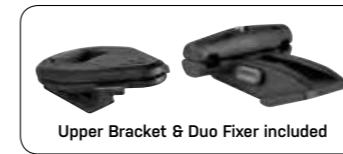

FLASHFENDER DF BLACK

ART NO. TDF-FFB



FLASHFENDER DF TRANSPARENT

ART NO. TDF-FFT



Included Duo Fixer provides dual use with Topeak Duo Fixer system compatible products to carry even more essentials



HYBRIDMASTER MINI

An inflation kit with HybridRocket technology combines the reliability of a mini pump with the rapid tire filling ability of a CO₂ inflator in a single unit. The extra compact pump and integrated CO₂ inflator lets you choose between pumping, inflating with CO₂ or a combination of both. Mounts to saddle rail with included Duo Fixer which provides dual use with Topeak Duo Fixer system accessoires, including Tubi tools, CO₂ inflators, lights, and fenders. A simple slide and click is all it takes to go on a safe and secure ride.

TOOLS	HybridRocket HP Mini, and two 16g CO ₂ cartridge
COMPATIBILITY	Upper - TubiMaster GX DF, NanoMaster DF, TailLux DF lights, and FlashFender DF with upper bracket
ATTACHMENT	Duo Fixer on saddle rail
ADDED FEATAURE	Mounting module, PCT Cap (Presta Core Tool Cap)
SIZE	16 x 9 x 5.3 cm / 6.3" x 3.5" x 2.1"
WEIGHT	270 g / 9.52 oz
ART NO.	TDF-HMM



Duo Fixer included



Clearance for additional mounting strap to secure inner tube

* Mounting strap & inner tube not included



Included Duo Fixer provides dual use with Topeak Duo Fixer system compatible products to carry even more essentials

HYBRIDROCKET HP MINI

PUMP HEAD	SmartHead® ThreadLock with integrated dust cap
INFLATOR HEAD	CNC aluminum Fits Presta / Schrader valves
BARREL	CNC aluminum
CAPACITY	160 psi / 11 bar
VOLUME PER STROKE	17.5 cc
HANDLE	Aluminum / Dual density polymer

SMARTHEAD TECHNOLOGY



16g CO₂ cartridge

Mounting Module

PCT Cap

16g CO₂ cartridge



2 Tire Levers included

* Mini tool & inner tube not included



FREEPACK

Free Pack provides an alternative way to pack most inner tubes with a mini tool or CO₂ cartridges for your ride. Mounts to saddle rail with included Duo Fixer which provides dual use with Topeak Duo Fixer system accessories, including Tubi tools, CO₂ inflators, lights, and fenders. A simple slide and click is all it takes to go on a safe and secure ride.

MATERIAL	Engineering grade polymer
ATTACHMENT	Duo Fixer on saddle rail
COMPATIBILITY	Upper - TubiMaster GX DF, NanoMaster DF, TailLux DF lights, and FlashFender DF with upper bracket
ADDED FEATURE	3 mounting straps, 2 tire levers included
SIZE	10.4 x 6.7 x 1.8 cm / 4.1" x 2.6" x 0.7"
WEIGHT	45 g / 1.59 oz
ART NO.	TDF-FP

DUO FIXER TECHNOLOGY



Includes mounting fixer with 3 mounting straps and two tire levers



Included Duo Fixer provides dual use with TailLux DF light for safety at night



Included Duo Fixer provides dual use with FlashFender DF when wet weather arrives



Included Duo Fixer provides dual use with Topeak TubiMaster GX DF or NanoMaster DF for tubeless tire repair and/or CO₂ inflation



Included Duo Fixer provides dual use with Topeak Duo Fixer system compatible products to carry even more essentials

BACKLOADER WITH BACKLOADER WISHBONE

A bag and anti-sway bar system that holds your gear in place and your ride balanced. Two additional water bottle mounts provide flexibility for those extra long adventures.



Anti-sway BackLoader Wishbone holds rear bikepacking bag rigid and keeps riding balanced



Twin bars can hold two additional bottle cages for extra hydration needs



Semi-rigid holster mounts to saddle rails and seatpost with hook and loop straps

10L / 610ci



Green
Art No. TBP-BLX2G



Black
Art No. TBP-BLX2B



15L / 915ci



Green
Art No. TBP-BLX3G



Black
Art No. TBP-BLX3B

BACKLOADER X

A large capacity seat bag specifically designed for bikepackers wanting a streamlined way to carry gear without the need for a rear rack. The reinforced, anti-slip/scratch fabric protects the saddle while the advanced mounting system enables convenient and secure mounting to seatpost and saddle rails. Easy access waterproof carry bag and built-in air release purge valve keeps bag compact and dry while you're on your next adventure.

MATERIAL	Polyethylene / Anti-slip PU leather / Nylon / Engineering grade polymer Lightweight, durable, water repellent and stain resistant
BAG ATTACHMENT	Holster with hook and loop fastener and buckle fastener
WATERPROOF RATING	10,000 mm (waterproof inner bag)
MAX LOAD CAPACITY	5 kg / 11 lb
ADDED FEATURES	Waterproof carry bag, Air release purge valve, Attachable rear light strap, Optional BackLoader Wishbone
SIZE	<p>10L 46 x 24 x 22 cm / 18.1" x 9.4" x 8.7"</p> <p>15L 51 x 24 x 22 cm / 20.1" x 9.4" x 8.7"</p>
WEIGHT	<p>10L 561 g / 19.79 oz (Black) 533 g / 18.69 oz (Green)</p> <p>15L 570 g / 20.10 oz (Black) 551 g / 19.43 oz (Green)</p>

WATERPROOF | STRAP MOUNT



Semi-rigid holster mounts to saddle rails and seatpost with hook and loop straps

Adventure ready saddle mounted removable drybag & holster system



Included waterproof carry bag keeps contents dry and easily accessible



Built-in **Air Release Purge Valve** purges extra air to fully compress the load



Rear light strap provision for nighttime safety



Install / remove waterproof carry bag quickly and easily



Optional anti-sway BackLoader Wishbone holds BackLoader X rigid and keeps riding balanced



Two Additional Bottle
Cage Mounts



Protection & Security



BACKLOADER WISHBONE

An anti-sway saddle mount holds rear bag rigid and keeps riding balanced for bikepacking enthusiasts. Made of aluminum alloy and stainless steel, stout and durable. The twin bars can hold two additional bottle cages for extra hydration needs.

MATERIAL	Aluminum alloy / Stainless steel / Engineering grade polymer	ADDED FEATURES	Two additional bottle cage mounts and water bottle cage bolts included
MAX LOAD	1 kg / 2.2 lb (Bottle Cage Mount each side)	SIZE	16.3 x 14.7 x 14.2 cm / 6.4" x 5.8" x 5.6"
MOUNT	Saddle rail	WEIGHT	190 g / 6.70 oz
COMPATIBILITY	Topeak BackLoader Rear bag width less than 18 cm / 7.1"	ART NO.	TBP-BLWB

Made of aluminum alloy and stainless steel, stout and durable



Anti-sway BackLoader Wishbone holds rear bikepacking bag rigid and keeps riding balanced



Twin bars can hold two additional bottle cages for extra hydration needs

Anti-sway stabilizer keeps riding balanced for bikepacking enthusiasts

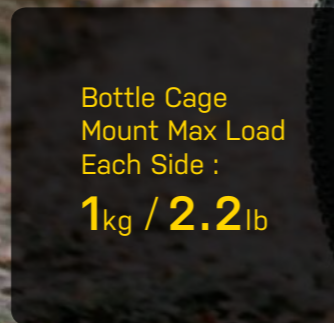

* Compatible with steel, CroMo, titanium, and carbon standard saddle rails
* Not compatible with monorail or spring type saddle rails

E-XPLORER TRUNKBAG

Built to go further! The E-Explorer TrunkBag is an eBike specific spare battery carrier made of rigid EVA foam and Polyethylene providing structure, excellent impact absorption, and water repellency. In addition to the expandable top section, the side panels expand to full panniers maximizing capacity. The grip straps secure a spare battery in place while 3M™ reflective strips and attachable rear light MOLLE-compatible strap add extra safety. Compatible with Topeak's MTX QuickTrack® 2.0 racks, there's even enough room to carry additional gear for your eMTB adventures!

COMPARTMENT	One compartment
CAPACITY	26 L / 1590 ci Battery dimension within 42 x 10 x 11 cm / 16.5" x 3.9" x 4.3"
INSULATION	Rigid EVA foam
MATERIAL	Polyethylene / Engineering grade polymer
BOX ATTACHMENT	MTX QuickTrack® 2.0 system with attached side panels and 3 additional hook and loop fasteners / Compatible with TetraRack M2L
MAX LOAD	Limited to rack max load rating
ADDED FEATURES	Carrying handle, 3M reflective strips, MOLLE-compatible strap for mounting safety light and additional strap to fasten to rack
SIZE	43.4 x 29.4 x 23.7 cm / 17.1" x 11.6" x 9.3"
WEIGHT	1217 g / 2.68 lb
ART NO.	TT9652



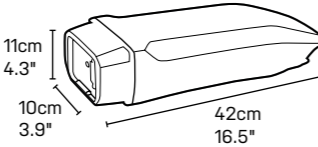

Maximum Battery Dimensions
42 x 10 x 11 cm / 16.5" x 3.9" x 4.3"

Compatible e-Bike Batteries:

- Bosch PowerPack 300/400/500 WH (2.9-3.5kg)
- Shimano Steps E8000 418/540/630 WH (2.9-3.5kg)
- Yamaha 400/500 WH (2.9kg)
- Brose 630 WH (3.5kg)

MTX QUICKTRACK 2.0

MTX QUICKTRACK® 2.0 SYSTEM

An advanced, easy-to-use attachment system allowing our E-Explorer TrunkBag to interface securely to the TetraRack M2L or Ranger Rack. Low profile clip reduces mounting interference with saddle and doesn't protrude when carrying bag. Simply slide the TrunkBag forward in the track until it locks in place. Push the release tab and your TrunkBox slides off the track and goes with you.



26L | 1590ci

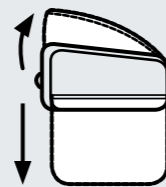

Expandable top section and side panels expand to full panniers maximizing capacity



Hook and loop fasteners secure spare battery



Built-in carrying handle for off bike convenience



3M™ reflective strips and attachable rear light MOLLE-compatible strap add extra safety



eBike specific MTX TrunkBag carries spare battery and extra gear





GEARPACK

A compact bag with three divided sections with internal organizers that hold things in place to eliminate noise from all your MTB or gravel bike gear. Neatly store tools and tire/tube repair essentials so you're always prepared for a riding adventure. Secure scratch-free straps provide tool-free mounting anywhere on your bike.

COMPARTMENTS	Three divided sections internal organizers	SEAT TUBE DIAMETER	Fits $\varnothing 35 - \varnothing 90$ mm
COMPATIBILITY	Up to 29" x 2.4" inner tube	SEATPOST DIAMETER	Fits $\varnothing 35 - \varnothing 90$ mm
MATERIAL	Nylon + elastic yarn, Phthalate-Free PVC, Polyurethane, Aluminum	SIZE	15 x 11 x 9 cm / 5.9" x 4.3" x 3.5"
BAG ATTACHMENT	Two scratch-free Polyurethane straps (13 x 330 mm)	WEIGHT	111 g / 3.91 oz (Bag) 13 g / 0.46 oz (Two PU straps)
TOP TUBE DIAMETER	Fits $\varnothing 35 - \varnothing 90$ mm	ART NO.	TC2279B

STRAP MOUNT



Secure scratch-free straps provide tool-free mounting anywhere on your bike

Uniquely Designed for Enduro, Gravel, and Touring Riders

3 DIVIDED SECTIONS



1 2 3

Labels for Easy Packing



*REPAIR KIT SUGGESTIONS

SECTION 1

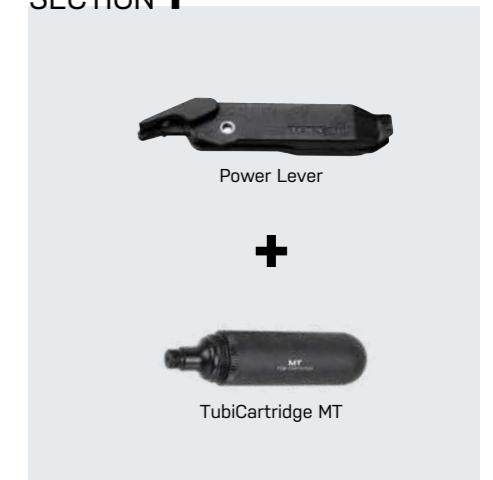

SECTION 2

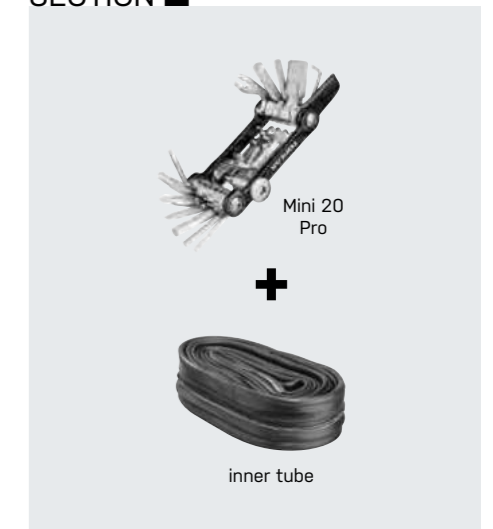

SECTION 3

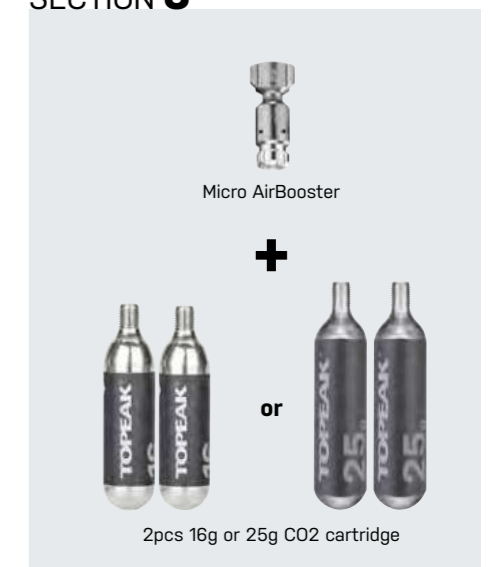

* Contents shown not included

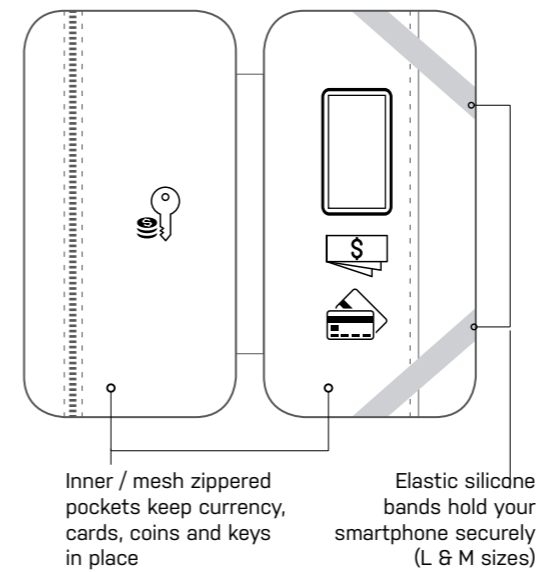

PAKGO® WALLET

A rigid wallet with soft velvet interior lining to protect your belongings is compact and well organized. Features inner / mesh zippered pockets to keep your smartphone, credit cards, currency, coins and keys in place and easy access with wide zippered opening. The elastic silicone bands holds your smartphone securely in place when the wallet is opened. Compact enough to fit in a jersey pocket.

CAPACITY	L size - For smartphones ≤ 17 x 8.8 x 1.7 cm / 6.69" x 3.46" x 0.67", credit cards, currency, coins and keys	SIZE	17.9 x 9.4 x 3.38 cm / 7" x 3.7" x 1.3" (L)
	M size - For smartphones ≤ 14.5 x 7.5 x 1.7 cm / 5.71" x 2.95" x 0.67", credit cards, currency, coins and keys		15.6 x 8.6 x 3.48 cm / 6.1" x 3.4" x 1.4" (M)
	S size - For credit cards, currency, coins and keys		12.2 x 8 x 3.43 cm / 4.8" x 3.1" x 1.4" (S)
COMPARTMENTS	One main, inner pockets	WEIGHT	122 g / 4.30 oz (L)
			106 g / 3.74 oz (M)
			72 g / 2.54 oz (S)
MATERIAL	Phthalate-Free PVC / EVA / Polyethylene / Silicone / Aluminum, Sweatproof	ART NO.	TPG-WL (L)
			TPG-WM (M)
			TPG-WS (S)

* Contents shown not included.

Wide zippered opening provides easy access to your smartphone and essentials



A compact and rigid with soft velvet interior wallet

PREPSTAND® eUP PRO

The PrepStand® eUP Pro is the first lift assisted foldable workstand – ideal for working on e-Bikes and other heavyweight bikes. Additional Reinforced Support Unit adds stability while a bike is mounted. The foot pedal operated, built-in pressurized cartridge, provides an additional 17kg (37lb) of lifting power making easy work of raising and lowering most bikes weighing up to 35kg (77lb). A 360° rotatable clamp head with non-marring jaws quickly and securely holds your bike stable for repairs, cleaning and general maintenance. Quick-release legs conveniently fold to a compact size for travel and storage.

CLAMP HEAD	Non-marring rubber jaws 360° rotation
CLAMP HEIGHT	105cm - 150cm
CLAMP OPENING	1.2cm - 9cm (Fits tubes \varnothing 22.2 - \varnothing 76.2mm)
FOLDING	QR clamp
MATERIAL	6061 T6 Tubes
ATTACHMENT	Seatpost
MAX LOAD	35 kg / 77 lb
ADDED FEATURES	Pressurized cartridge, Rubber base feet, Built-in 4" wheel, Optional tool tray, Optional storage bag (Art No. TWB030)
SIZE	114 x 112 x 92 cm / 44.9" x 44.1" x 29.9" (Open) 112 x 24 x 21 cm / 44.1" x 9.4" x 8.3" (Folded)
WEIGHT	13 kg / 28.66 lb
ART NO.	TW031 TRK-N085 (Reinforced Support Unit)



Effortlessly raise and lower heavyweight bikes with pressurized cartridge lift assist

Patented pressurized cartridge technology provides lift assist for heavy bikes with ease



Reinforced Support Unit (Art No. TRK-N085)

Included Reinforced Support Unit adds stability for heavyweight bikes



Extra long legs increase stability



Speed levers add convenience for rotating clamp head and clamping rubber jaws



Clamp head features non-marring rubber jaws won't harm finish. Fits tubes \varnothing 22.2 - \varnothing 76.2mm



Large foot pedal operated for easy height adjustment



Built-in 4" wheel makes moving stand easy



Optional storage bag available (Art No. TWB030)

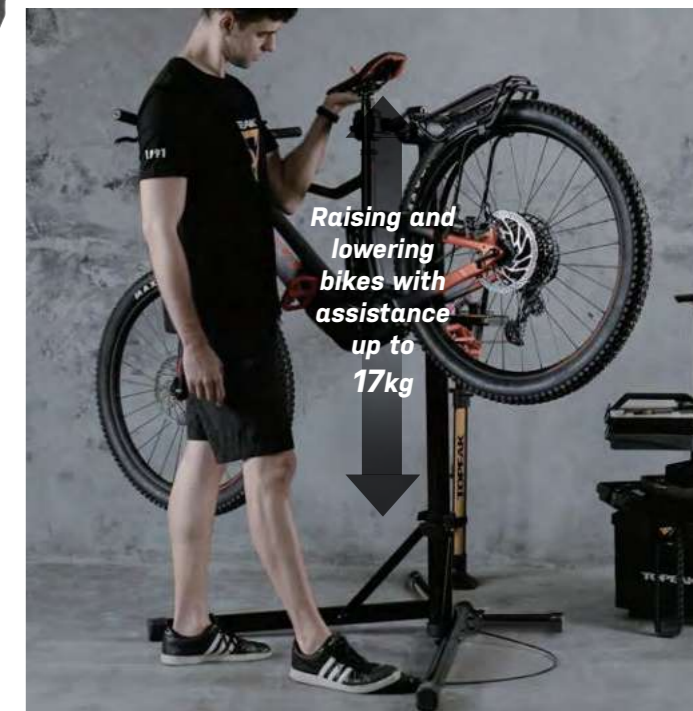

Raising and lowering bikes with assistance up to 17kg



BIKE TRUSS 3X

Unique adjustable 3-point clamp design used with a bicycle repair stand to provide stability and eliminate damage to thin-walled and aero-shaped tubes. The adjustable clamp length, 3 contact clamping positions and adjustable rubber straps fit any bicycle frame and mounts on a repair stand closer to the bike's center of gravity improving stability. Included handlebar stabilizer is length adjustable to fit most bikes to keep its handlebar and front wheel secure. Compatible with Topeak PrepStand Pro, PrepStand Elite, or other repair stands with clamping jaws. Folds down compactly for storage.

ATTACHMENTS	Top tubes and seat tube	SIZE	62.8 x 14.5 x 31.5 cm / 24.7" x 5.7" x 12.4" (Clamp open) 38.3 x 14.5 x 12.5 cm / 15.1" x 5.7" x 4.9" (Clamp Folded)
FOLDING	Adjustable clamp length	ADDED FEATURE	Handlebar Stabilizer included
MATERIAL	Aluminum / Engineering grade polymer	WEIGHT	1.3 kg / 2.87 oz
MAX LOAD	20 kg / 44 lb	ART NO.	TW032

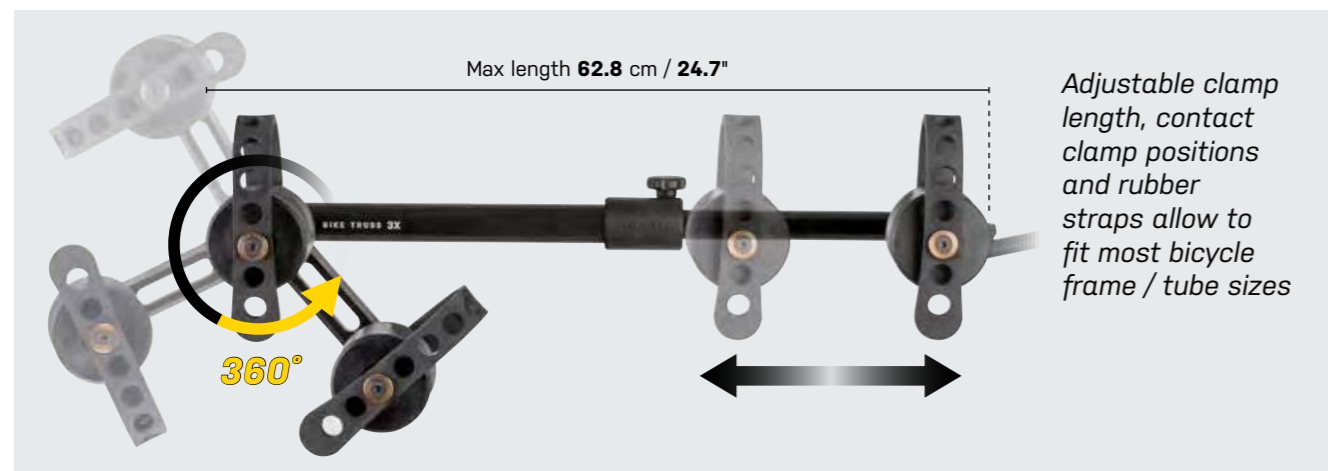

Adjustable clamp length, contact clamp positions and rubber straps allow to fit most bicycle frame / tube sizes



Fold for compact storage



Silicone cups eliminate possible crushing or damage to thin-walled and aero-shaped tubes



Handlebar Stabilizer secures front wheel and handlebar when in work stand

ROAD



Unique adjustable 3-point clamp design fits a wide range of bicycle frames for use with jaw clamp type repair stands

MOUNTAIN



ROAD

S



GRAVEL

ST S



MTB

FS DT ST

D-Flash Express **FS** (Fork or Seatstays)D-Flash Express **DT** (Downtube)D-Flash Express **S** (Saddle Rail)D-Flash Express **ST** (Seat Tube)

Fork / Seatstays version for all mountain bikes



Downtube version for all mountain bikes



Saddle rail version for road bikes



Seat tube version for mountain and gravel bikes

D-FLASH EXPRESS

D-FLASH EXPRESS

Ingeniously Efficient! Durable polypropylene fenders are ultralight, stylish, quickly attach and ready to go when wet weather arrives - no assembly of the fender required. Simply remove from the packaging and fold along the perforated line to mount with hook and loop straps which provide fenders to fit a wide range of bikes and keep you and your bike cleaner.

MATERIAL	Polypropylene
ATTACHEMENT	Fork / Seatstays (FS version) Downtube (DT version) Saddle rail (S version) Seat Tube (ST version)
SIZE	28 x 27 x 0.08 cm / 11" x 10.6" x 0.03" (FS) 34.2 x 16.5 x 0.08 cm / 13.5" x 6.5" x 0.03" (DT) 34 x 8.8 x 0.08 cm / 13.4" x 3.5" x 0.03" (S) 52 x 10 x 1 cm / 20.5" x 3.9" x 0.4" (ST)

WEIGHT	26 g / 0.92 oz (FS) 32 g / 1.13 oz (DT) 16 g / 0.56 oz (S) 39 g / 1.38 oz (ST)
---------------	---

ART NO.	TC9657 (FS) (on fork or seatstays) TC9656 (DT) (on downtube) TC9655 (S) (on saddle rail) TC9658 (on seat tube)
----------------	---

TETRAFENDER

M1 (Front)



M2 (Rear)

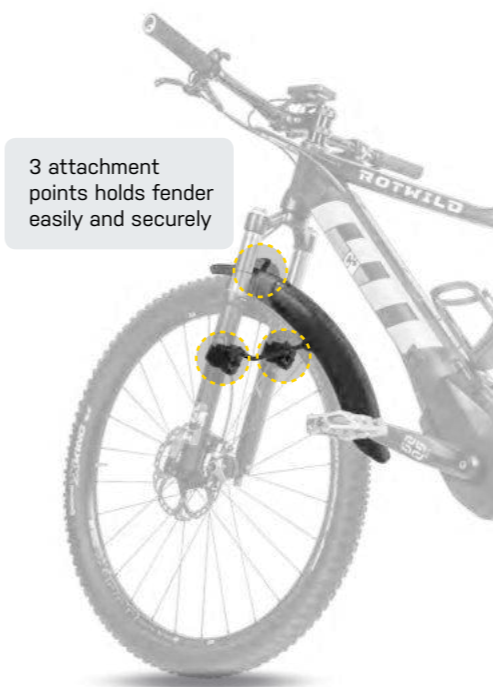

Compatible with all frame materials and finishes

Co-molded Fender is Lightweight and Durable



Adjustable Aluminum Struts for Good Tire Coverage

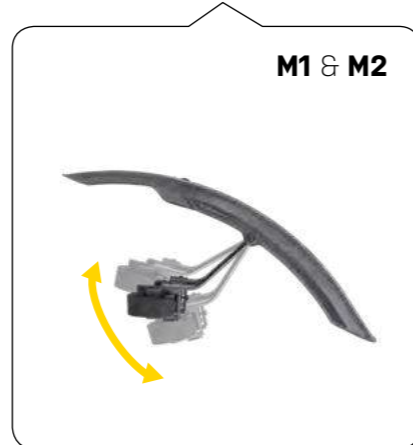

Maximum 3.2 cm adjustable fender length



Unique Two-Piece, Dual Tone Design

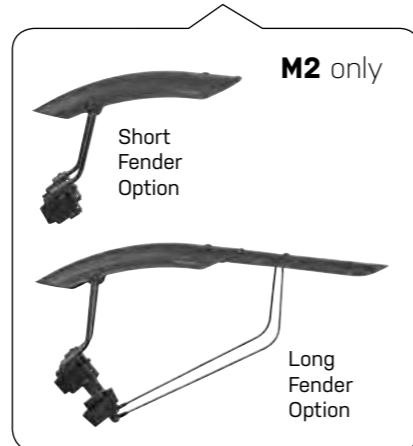

TETRAFENDER M1 & M2 SET

ART NO. TC9662 (Set)



Unique two-piece, dual tone design provides short and long fender options for a perfect fit on your bike



TETRAFENDER M1

The perfect quick-mount, dual color front fender that attaches to MTB forks with hook and loop straps easily and securely. Adjustable aluminum struts provide a closer fit to the tire and excellent mud / spray protection while the highly polished underside helps prevent dirt buildup and aids in cleaning.

ATTACHMENTS	Fork attachment with hook and loop straps	26"-29" wheel sizes with tire width up to 2.8" Compatible with all frame materials and finishes
ADJUSTMENT	Angle adjustable	
MATERIAL	Two tone injected high impact resistant plastic with aluminum struts	SIZE 48 x 17.2 x 14.2 cm / 18.9" x 6.8" x 5.6"
COMPATIBILITY	Front fork width within 115 - 145mm	WEIGHT 230 g / 8.11 oz ART NO. TC9660

FOR 26" - 29" WHEELS

TETRAFENDER M2

The perfect quick-mount rear fender system attaches to MTB with hook and loop straps easily and securely. Adjustable fender length provides a closer fit to the tire and excellent mud / spray protection. Unique two-piece, dual tone design provides short or longer fender usage options for a perfect fit with your bike. A highly polished underside helps prevent dirt buildup and aids in cleaning.

ATTACHMENTS	Seatstays with hook and loop straps	Compatible with all frame materials and finishes
ADJUSTMENT	Adjustable fender length	ADDED FEATURE Short and long sizes
MATERIAL	Two tone injected high impact resistant plastic with aluminum struts	SIZE 49.8 x 32.4 x 14.2 cm 19.4" x 12.8" x 5.6"
COMPATIBILITY	Seatstays width within 95 - 125mm 26"-29" wheel sizes with tire width up to 2.8"	WEIGHT 360 g / 12.70 oz ART NO. TC9661

FOR 26" - 29" WHEELS

MOUNT WITH **TETRARACK M2** (Rear)



MOUNT WITH **TETRARACK M2L** (Rear)



Multiple Assembly Positions

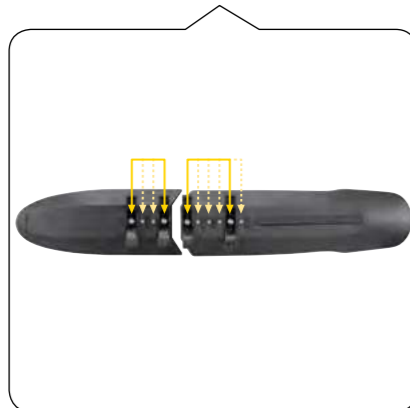

Unique Two-Piece, Dual Tone Design



TETRARACK FENDER M2

The perfect quick-mount rear fender system attaches to TetraRack M2 or M2L with spring steel mounting clips easily and securely for MTB. Unique two-piece, dual tone with multiple mounting position and adjusting option design provide a closer fit to the tire and excellent mud / spray protection. A highly polished underside helps prevent dirt buildup and aids in cleaning.

ATTACHMENTS	Attach underneath TetraRack
ADJUSTMENT	Multiple mounting and adjusting position options
MATERIAL	Two tone injected high impact resistant plastic with spring steel mounting clips
COMPATIBILITY	TetraRack M2 / M2L, Seatstays width within 95-125mm, 26"-29" wheel sizes with tire width up to 2.8"
SIZE	53 x 9.1 x 5.5 cm / 20.9" x 3.6" x 2.2"
WEIGHT	125 g / 4.41 oz
ART NO.	TC9663

FOR 26" - 29" WHEELS

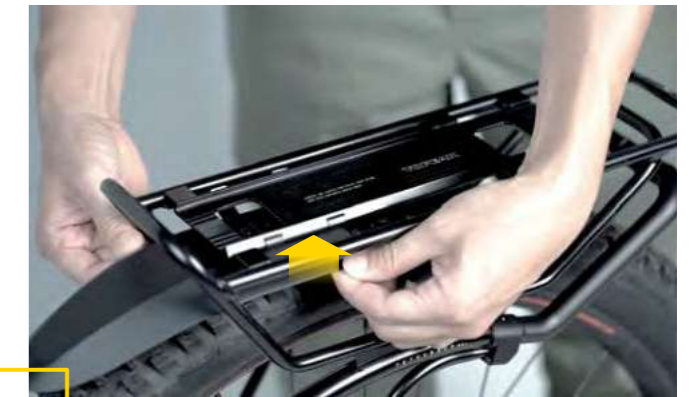
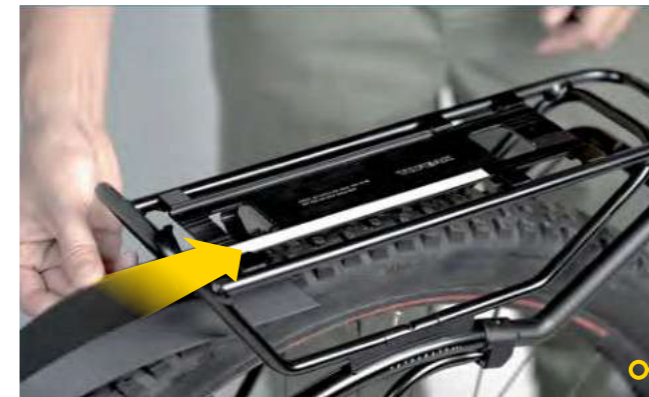

Simply clips fender on TetraRack M2 or M2L with spring steel mounting clips easily and securely

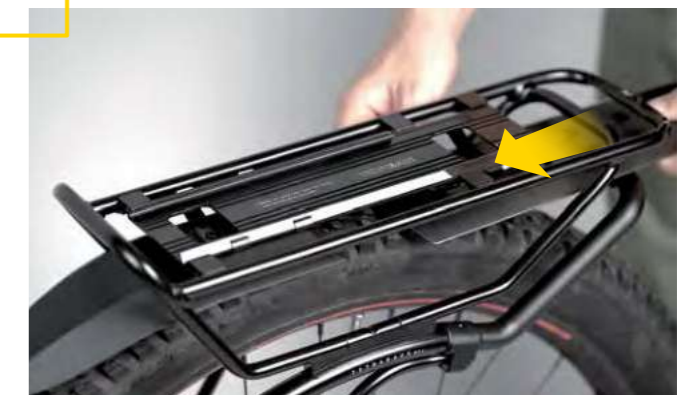

Two-piece design provides front and rear piece forward or backward adjustment, or even separate them for a closer fit to the tire



R10 TUBULAR CARBON

(Fezā Bottle Glide included)



Black
Art No. TFZ-R10B

KEVLAR CARBON

(Fezā Bottle Glide included)



Blue
Art No. TFZ-R10KB



Red
Art No. TFZ-R10KR

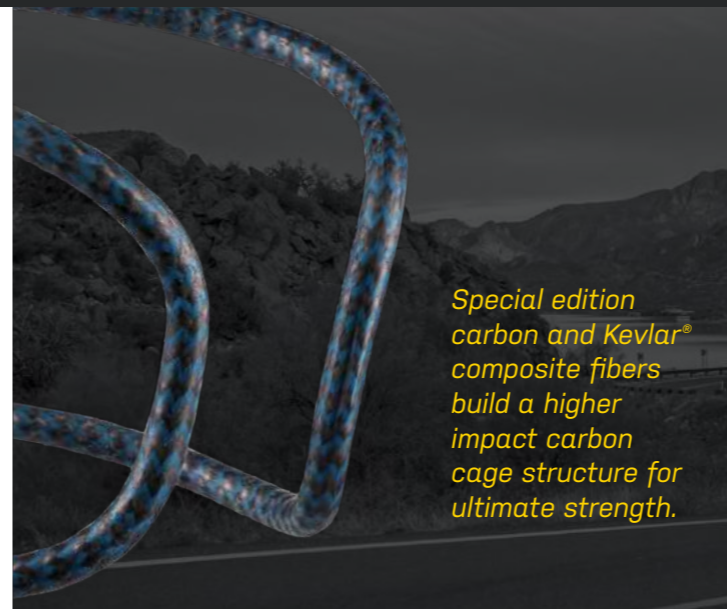

ROADIE

10g

Fezā Bottle Glide
R10 cage comes with mount optional Bottle Glide to ease entry and access to your water bottle while also protecting your frame's finish from bottle abrasion.

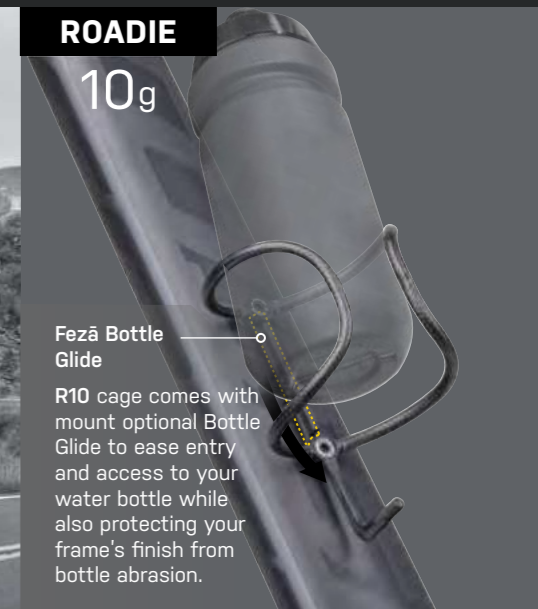

G12 TUBULAR CARBON



Black
Art No. TFZ-G12B

KEVLAR CARBON



Blue
Art No. TFZ-G12KB



Red
Art No. TFZ-G12KR



GRAVEL

12g

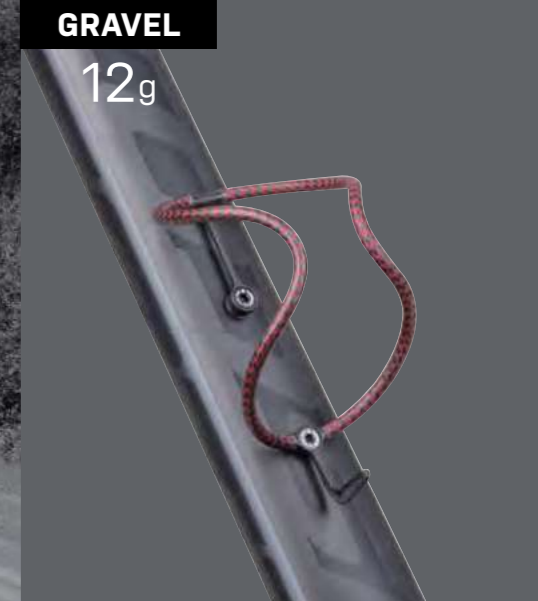

MT16 TUBULAR CARBON



Black
Art No. TFZ-MT16B

KEVLAR CARBON



Blue
Art No. TFZ-MT16KB



Red
Art No. TFZ-MT16KR

Fezā CAGE

The featherlight, carbon fiber composite $\phi 5.5\text{mm}$ (R10 / G12) / $\phi 6.5\text{mm}$ (MT16) tube cage offers high strength with minimal shape and less weight. Includes two stainless steel bolts ready to mount and enjoy on your ride.

MATERIAL Carbon fiber (Black version)
Carbon and Kevlar® composite fibers (Kevlar Blue / Red versions)

DIAMETER Fits standard water bottles

ADDED FEATURES Fezā Bottle Glide, Two aluminum water bottle bolts and T20 Torx® wrench included

SIZE 11.7 x 8 x 8 cm / 4.6" x 3.1" x 3.1" (R10)
14.5 x 8 x 8 cm / 5.7" x 3.1" x 3.1" (G12)
14.6 x 8.4 x 8.4 cm / 5.75" x 3.3" x 3.3" (MT16)



MOUNTAIN

15.5g



BOTTLE CAGE & CAGEMOUNTS FOR APPLE AIRTAG

Take the advantage of Apple AirTag to locate your bike and ride with your group. Introducing our special design bottle cage and CageMounts for Apple AirTag that integrates the tracker inside our new bottle cage or CageMounts for your bike to locate your position and keep you on track with your riding group for a safe and fun ride.



NINJA+ CAGE Z
With AirTag Mount

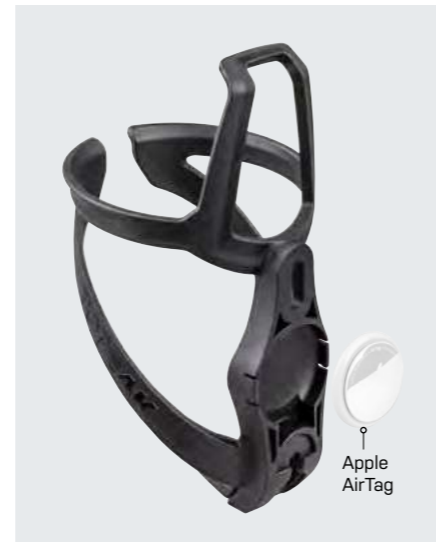

Apple
AirTag



Two anti-theft stainless steel bolts and
Allen wrench included



Allows you to add tools, CO₂ inflator kit or
inner tube holder with Ninja+ Cage accessories
(available separately)

NINJA+ CAGE Z WITH AIRTAG MOUNT

Apple AirTag holder integrated with the ultimate water bottle cage grips your bottle securely and keeps you on track with your riding group for a safe and fun ride. For additional safety, two anti-theft stainless steel bolts and Allen wrench are included.

MATERIAL	Engineering grade polymer
CAGE OUTER DIAMETER	Fits standard water bottles
COMPATIBILITY	Apple AirTag, Ninja+ Cage accessories
SIZE	14.9 x 8.4 x 7.8 cm / 5.9" x 3.3" x 3.1"
WEIGHT	37 g / 1.30 oz
ART NO.	TNJZ-AT



NINJA+ CAGEMOUNT
For AirTag



Apple
AirTag



Requires to mount with Ninja+ cage
(available separately)

NINJA+ CAGEMOUNT FOR AIRTAG

Apple AirTag holder integrated with the Ninja+ CageMount mates with any Ninja+ cage series. It grips your bottle securely and keeps you on track with your riding group for a safe and fun ride.

MATERIAL	Engineering grade polymer
COMPATIBILITY	Apple AirTag, Ninja+ Cage series
ADDED FEATURE	2mm Allen Key included
WEIGHT	11 g / 0.39 oz
ART NO.	TNJCM-AT



CAGEMOUNT
For AirTag

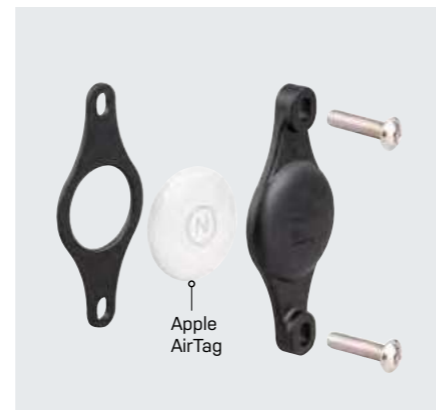

Apple
AirTag



Two anti-theft stainless steel bolts and
Allen wrench included



Use alone or combine with any bottle cage on
water bottle bosses

CAGEMOUNT FOR AIRTAG

Apple AirTag holder integrated in the CageMount combines with any bottle cage or can be used separately to keep you on track with your riding group for a safe and fun ride. For additional safety, two anti-theft stainless steel bolts and Allen wrench are included.

MATERIAL	Engineering grade polymer
COMPATIBILITY	Apple AirTag, any bottle cages
ADDED FEATURES	Two anti-theft stainless steel bolts and Allen wrench included
SIZE	7.7 x 3.45 x 0.9 cm / 3" x 1.36" x 0.35"
WEIGHT	8 g / 0.28 oz
ART NO.	TCM-AT



650 ml / 22 oz



750 ml / 25 oz



TOPEAK TEAM ISSUE BOTTLE



Dual Material cap design enhances top cap handling

A BPA-free, taste-free, soft, and lightweight polyethylene water bottle



Fully recyclable leak-proof jet valve

TTi® BOTTLE

The Topeak Team Issue (TTi) water bottle is BPA-free, taste-free, soft, and made of lightweight polyethylene featuring a fully recyclable leak-proof jet valve, TPR nozzle, silicone cap ring, and squeezable body for safe, simple and effective hydration. The bottle is available in two sizes - 650ml / 22oz and 750ml / 25oz, and 2 colors - black and white.

MATERIAL	Lightweight polyethylene
VOLUME	650 ml / 22oz 750 ml / 25 oz
TEMP RANGE	Temperatures -10C to 70C degrees (-14F to 158F degrees)
ART NO.	TB-650B (650 ml, Black) TB-650W (650 ml, White) TB-750B (750 ml, Black) TB-750W (750 ml, White)





Stealth and multiple combination design keeps your riding adventure safe



+

ASSEMBLY WITH **OPTIONAL UTF MULTIT-MOUNT**



UTF Multi-Mount
Fits $\varnothing 25.4$ - $\varnothing 31.8$ mm
Handlebars
(Art No. TC1035)

OR



UTF Multi-Mount
Fits 4-Bolt Stems
(Art No. TC1036)



UTF BELLONSIDE

Simply assemble a bell to Topeak UTF Mult-Mount (Handlebar or 4-Bolt Stem version) to hide under your mounted smartphone or cycle computer. A friendly warning of your approach with a beautifully clear ring tone when it is needed. This bell is definitely a delightful companion for all your cycling adventures.

MATERIAL Bronze / Stainless Steel / Engineering grade polymer

WEIGHT 64 g / 2.26 oz

COMPATIBILITY Topeak UTF Multi-Mount (Fits $\varnothing 25.4$ - $\varnothing 31.8$ mm Handlebars) and UTF Multi-Mount (Fits 4-Bolt Stems)

ART NO. TC1041

SIZE 7.2 x 6 x 5.6 cm / 2.8" x 2.4" x 2.2"



Assembly with UTF Multi-Mount (Handlebar version) that mounts on handlebars



Assembly with UTF Multi-Mount (4 Bolt stem version) that mounts to stem faceplates

MOTORCYCLE RIDECASES & MOUNTS

CNC machined aluminum, durable, convenient & secure smartphone mounts with Omni RideCase for motorcycles & scooters.



Securely attach & remove in seconds with RideCase QuickClick® mounting system



Ideal to attach GoPro® for snapping scenic shots on your ride



Full angle adjustment is perfect for navigation

MOTORCYCLE RIDECASE® MOUNT HB WITH OMNI RIDECASE FOR HANDLEBARS

A CNC machined aluminum motorcycle handlebar mount with Omni RideCase that provides a combination of security, stable viewing convenience and an easy way to snap some scenic shots on your ride. The high quality, ultra-elastic silicone case holds tight and works with almost every smartphone having a 4.5" to 6.5" screen with or without a case. There's full angle adjustment in landscape or portrait orientation and you can mount or remove your smartphone in seconds with RideCase QuickClick® mounting system. Also compatible with Topeak RideCases or Smartphone DryBags (available separately).

MATERIAL	CNC machined aluminum / Engineering grade polymer / Ultra-elastic silicone
MOUNT	Fits $\varnothing 22.2$ - $\varnothing 31.8$ mm handlebars (sizing shims included)
COMPATIBILITY	Topeak RideCases, Omni RideCase, SmartPhone DryBags, and GoPro® series
ADDED FEATURES	Angle adjustable Rotates for landscape or portrait viewing Integrated GoPro® adapter
WEIGHT	26 g / 0.92 oz (Case) 186 g / 6.56 oz (Mount)
ART NO.	TC1040

QUICKCLICK TECHNOLOGY

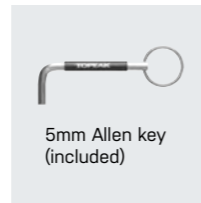

Multiple pivots for angle adjustment



Rotates for landscape or portrait viewing



Independent GoPro® adapter rotates for perfect viewing



Omni RideCase mounts in landscape view



Omni RideCase mounts with GoPro® in portrait view

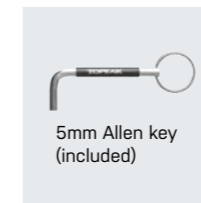

Multiple pivots for angle adjustment



Rotates for landscape or portrait viewing



Independent GoPro® adapter rotates for perfect viewing



Omni RideCase mounts in landscape view



Omni RideCase mounts with GoPro® in portrait view



Omni RideCase mounts in portrait view

MOTORCYCLE RIDECASE® MOUNT RM WITH OMNI RIDECASE FOR REAR MIRRORS

A CNC machined aluminum rearview mirror mount with Omni RideCase that provides a combination of security, stable viewing convenience and an easy way to snap some scenic shots on your ride. The high quality, ultra-elastic silicone case holds tight and works with almost every smartphone having a 4.5" to 6.5" screen with or without a case. There's full angle adjustment in landscape or portrait orientation and you can mount or remove your smartphone in seconds with RideCase QuickClick® mounting system. Also compatible with Topeak RideCases or Smartphone DryBags (available separately).

MATERIAL	CNC machined aluminum / Engineering grade polymer / Ultra-elastic silicone
MOUNT	Rearview mirror stems ($\varnothing 8$ and 10 mm)
COMPATIBILITY	Topeak RideCases, Omni RideCase, SmartPhone DryBags, and GoPro® series
ADDED FEATURES	Angle adjustable Rotates for landscape or portrait viewing Integrated GoPro® adapter
WEIGHT	26 g / 0.92 oz (Case) 132 g / 4.66 oz (Mount)
ART NO.	TC1039

QUICKCLICK TECHNOLOGY

Stronger and Optimal Cushioned Rubber



Flipstand for Post Ride Hands-free Viewing



Compatible with Lightning cable charging



* Remove iPhone from RideCase for wireless charging

Mounts on Stem Cap, Stem or Handlebar

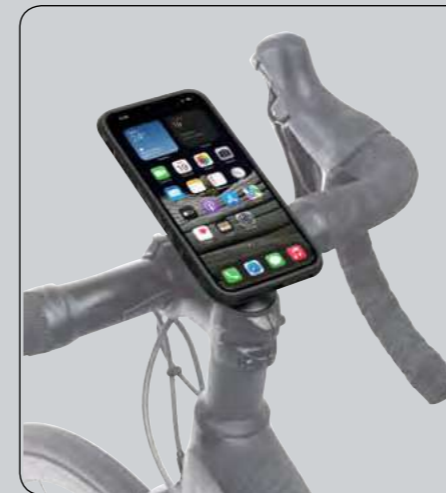

RideCase Mount lets you mount or remove RideCase in seconds



RideCase Mount Included (with RideCase Mount version)

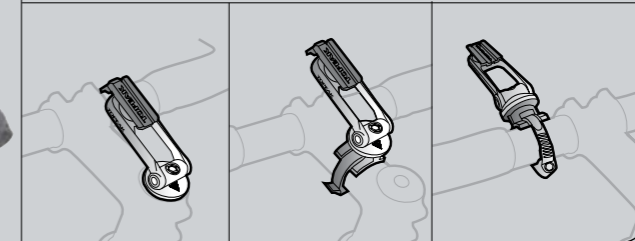

Full angle adjustment

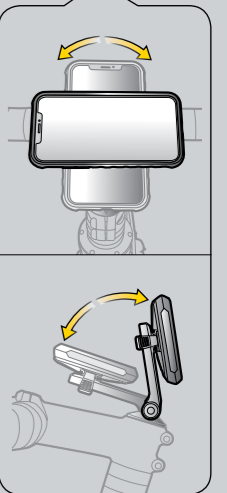

Works with iPhone 13 Pro Max

Works with iPhone 13 Pro

Works with iPhone 13

Works with iPhone 13 Mini

RIDECASE® Works with iPhone 13 Series

- Shock and Impact resistant iPhone case
- Unique QuickClick mount attaches on bike securely
- Full angle adjustment allows viewing in portrait or landscape modes
- Integrated flipstand for post ride hands-free viewing
- Compatible with Lightning cable charging
- Remove iPhone from RideCase for wireless charging

MATERIAL	Engineering grade polymer / Rubber / Machined aluminum
MOUNT	Included mounts for installation on handlebar, stem or stem cap (with RideCase Mount version)

WORKS WITH IPHONE 13 PRO MAX	WORKS WITH IPHONE 13 PRO / 13	WORKS WITH IPHONE 13 MINI
SIZE 16.9 x 8.6 x 15 cm / 6.7" x 3.4" x 0.59"	SIZE 15.4 x 7.9 x 15 cm / 6.1" x 3.1" x 0.59"	SIZE 13.9 x 7.2 x 14.9 cm / 5.5" x 2.8" x 0.59"
WEIGHT 55 g / 1.94 oz (Case)	WEIGHT 44 g / 1.55 oz (13 Pro)(Case) 45 g / 1.59 oz (13)(Case)	WEIGHT 39 g / 1.38 oz (Case)
ART NO. With RideCase Mount TT9873BG Case only TRK-TT9873BG	ART NO. With RideCase Mount TT9872BG (13 Pro) TT9871BG (13) Case only TRK-TT9872BG (13 Pro) TRK-TT9871BG (13)	ART NO. With RideCase Mount TT9870BG Case only TRK-TT9870BG

OPTIONAL MOUNTS

RIDECASE MOUNT
Art No. TC1023 (w/ 1 1/4" stem cap)
Art No. TC1021 (w/ 1 1/8" stem cap)

BIKE

ARM

RIDECASE ARMBAND
Art No. TC1027

UTF MULTI-MOUNT
(Fits ø25.4-ø31.8mm handlebars)
Art No. TC1035

UTF MULTI-MOUNT
(Fits 4-Bolt stems)
Art No. TC1036

MOTORCYCLE

CAR WINDSCREEN

RIDECASE CARMOUNT
Art No. TC1024

MOTORCYCLE RIDECASE MOUNT RM
(Rear Mirror)
Art No. TC1039

MOTORCYCLE RIDECASE MOUNT HB
(Handlebar)
Art No. TC1040

OMNI CARMOUNT
Art No. TC1031



3M™ is a registered trademark of 3M Company. Shimano® is a registered trademark of Shimano Inc. SRAM® is a registered trademark of SRAM Inc. Mavic® is a registered trademark of MAVIC SAS. Campagnolo® is a registered trademark of Campagnolo S.r.l. Torx® is a registered trademark of the Camcar Corp. division of Textron Inds. GoPro® is a registered trademark of GoPro, Inc. Garmin® is a registered trademark of Garmin Ltd. Wahoo® is a registered trademark of Wahoo Fitness. FSA® is a registered trademark of Full Speed Ahead Inc. Ritchey® is a registered trademark of Ritchey Design Inc. Scott® and SYNCROS® are the registered trademarks of SCOTT Sports SA. Most® is a registered trademark of Cici Pinarello SRL. Canyon® is a registered trademark of Canyon Bicycles GmbH. Sigma® is a registered trademark of SIGMA-ELEKTRO GmbH. Racktime® is a registered trademark of tubus carrier systems GmbH. KLICKfix® is a registered trademark of RIXEN & KAUL GmbH. Bosch is a registered trademark of Robert Bosch GmbH. Yamaha is a registered trademark of Yamaha Motor Co., Ltd. Brose is a registered trademark of Brose Fahrzeugteile SE & Co. KG, Coburg. Toray is a registered trademark of Toray Industries, Inc. iPhone and AirTag™ are the registered trademarks of Apple Inc.